

Information

For more information, advice and tips concerning our products contact your photo dealer, the distributor of NOVOFLEX products in your country (have a look at the "Where to buy" section at our website to find your distributor) or visit our website www.novoflex.com

For personal advice about possible accessories which is suitable for your NOVOFLEX product please contact the following phone number or send us an E-mail.

NOVOFLEX Phone: +49 8331 88888

NOVOFLEX E-Mail: mail@novoflex.com

© NOVOFLEX Präzisionstechnik GmbH
Brahmsstraße 7
D-87700 Memmingen
Phone +49 8331 88888, Fax +49 8331 47174
Email mail@novoflex.com, Internet www.novoflex.com

N
NOVOFLEX

CASTEL-MICRO

USER MANUAL

N
NOVOFLEX



Congratulations on your purchase of the new stepping motor driven CASTEL-MICRO focusing rack. Even if the operation is very simple, we want to give you some tips on how to use your CASTEL-MICRO right from the beginning.

Content

Nomenclature.....	2	SETTINGS.....	14
Focusing rack and accessories.....	2	Setting up start and end position....	14
Control unit.....	4	Setting up step length, shots etc....	15
Cable connections.....	5	Step Mode.....	15
Product description.....	6	Picture Mode.....	15
Focus-Stacking.....	6	Continuous Mode.....	16
Technical data.....	7	Bellows Mode.....	16
Safety instructions.....	8	STACKING.....	17
Preparations.....	9	Workflow and recommendations.....	18
Operation.....	11	Picture Mode.....	18
Switching on and off.....	11	Step Mode.....	20
Calibration.....	11	Examples.....	22
Main menu and modes.....	12	Recommended accessories.....	23
CAMERA.....	13	Information.....	24

Nomenclature

Focusing rack and accessories

1	Connection camera cable 3pin / 2.5 mm jack
2	Connection control unit RJ45 (no Ethernet)
3	Sliding block
4	Clamping screw
5	Quick release unit type Q=MOUNT with spirit level
6	Spindle
7	Guideway holes (for accessories like our CASTEL-COP-DIGI)
8	Dovetail (ARCA-type)
9	Milling cutout for safety pin
10	Tripod mount 3/8" (next to it more 1/4" and 3/8" threads)
11	Camera plate typ Q=PLATE (not within the scope of delivery)

Recommended accessories

Microscope lens
MITUTOYO M-PLAN
Apo 5x or 10x, more
M-PLAN lenses for
other magnifications
on demand.



Double clamp with
clamping plate
ASTAT-MICRO

Tube with achromat
MICRO-TUBE

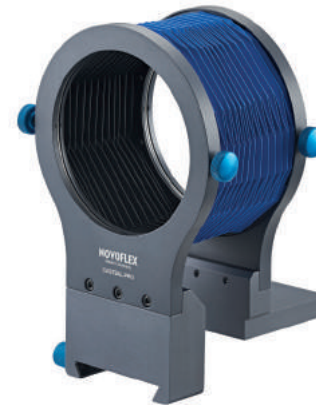

Bellows attachment **CASTBAL-PRO**
compatible with BALPRO accessories
such as the shift adapter PROshift +
and the extension tube PRO50.



Clamping plate of
type Q=PLATE for
mounting the camera,
here **QPL3**

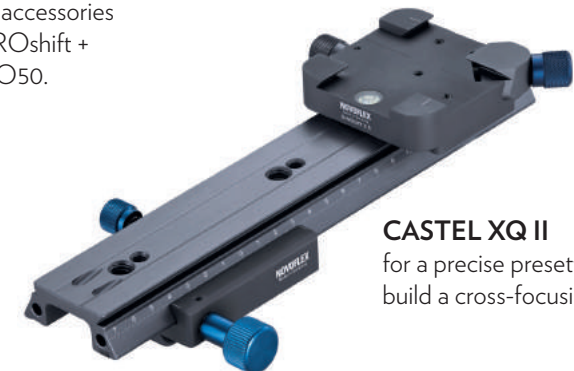

CASTEL XQ II
for a precise presetting or to
build a cross-focusing rack

Examples



Result of a stack of 150 exposures at f-stop 8, magnification approx. 10:1, step length 0.008 mm, full-frame camera and MITUTOYO M-Plan Apo 10x lens.



Result of a stack of 20 shots at f-stop 5.6, magnification approx. 1:2, step length 0.8 mm, full-frame camera with bellows attachment CASTBAL-PRO and Apo-Digitar 4.5 / 90mm lens.

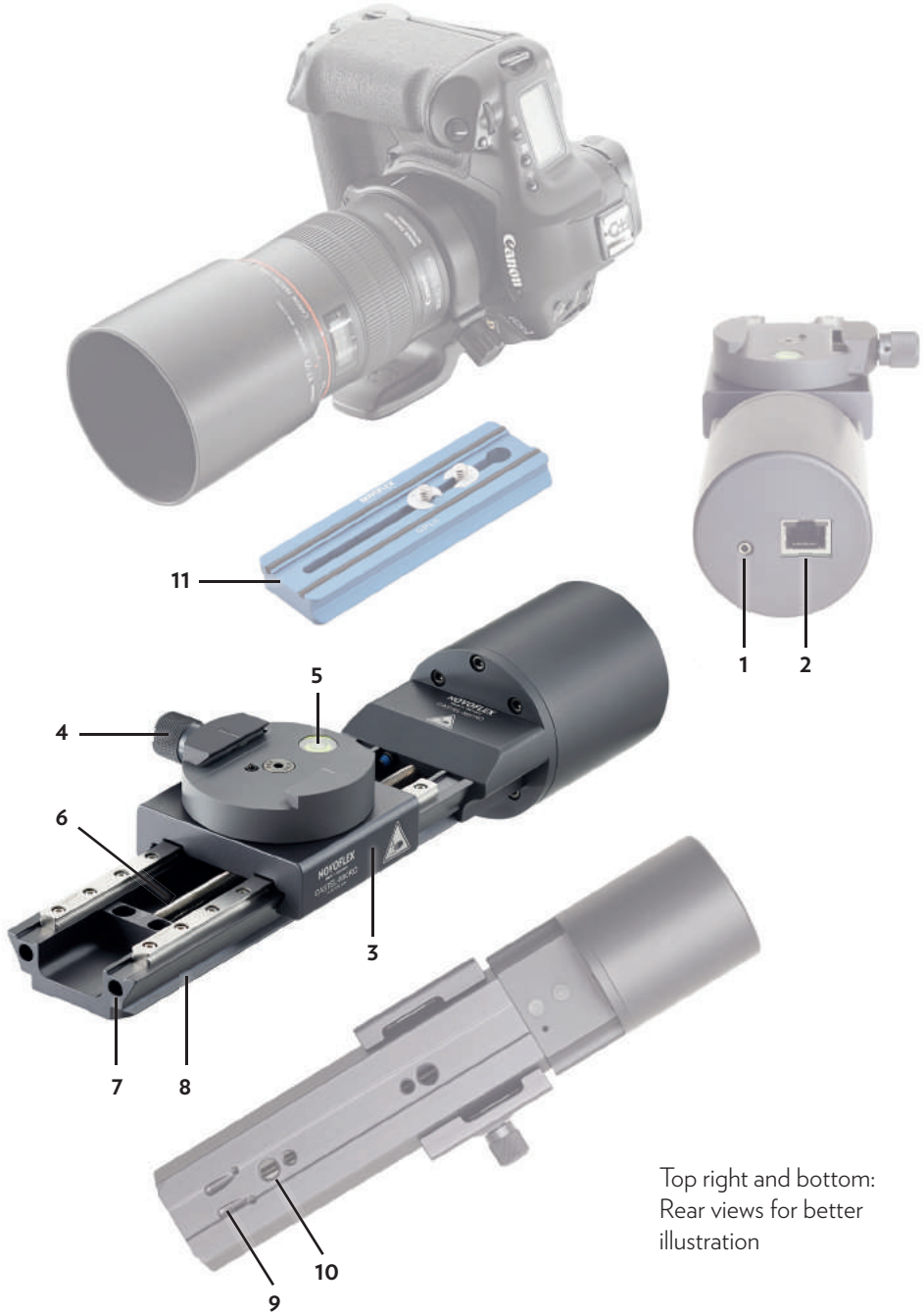

Top right and bottom:
Rear views for better
illustration

Control unit

12	Rotary knob (can be pressed and turned)
13	Touchscreen Display
14	3/8" threaded hole with 1/4" adapter
15	Connection focusing rack type RJ45 (no Ethernet)
16	12V power connector for power adapter
17	Service connection (only for service work)
18	Battery holder for 2 LP-E6 batteries
19	Battery type LP-E6 (not within the scope of delivery)



Rear view for better illustration

Depth of field in mm

at the permissible circle of confusion diameter of 0.025 mm

	F-stop →									
	2,0	2,8	4,0	5,6	8	11	16	22	32	
Magnification ↓	1:10	11,000	15,400	21,800	30,400	42,800	57,500	77,600	93,600	D*
	1:7,5	6,350	8,900	12,700	17,600	24,800	33,300	44,900	51,600	D*
	1:5	2,990	4,190	5,960	8,290	11,700	15,400	20,500	22,600	D*
	1:4	1,990	2,790	3,970	5,490	7,680	10,300	13,700	15,300	D*
	1:3	1,200	1,670	2,370	3,290	4,610	6,050	7,960	D*	D*
	1:2	0,598	0,834	1,190	1,630	2,270	2,960	3,690	D*	D*
	1:1,5	0,374	0,521	0,740	1,020	1,400	1,810	2,080	D*	D*
	1:1	0,199	0,276	0,392	0,538	0,718	0,880	D*	D*	D*
	2:1	0,074	0,102	0,142	0,189	0,231	D*	D*	D*	D*
	3:1	0,044	0,060	0,080	0,109	D*	D*	D*	D*	D*
4:1	0,030	0,041	0,054	0,071	D*	D*	D*	D*	D*	
5:1	0,023	0,030	0,037	D*	D*	D*	D*	D*	D*	
10:1	0,009	D*	D*	D*	D*	D*	D*	D*	D*	

D* = Diffraction

Depth of field in mm

with Mitutoyo lenses at the permissible circle of confusion diameter of 0.025 mm

Lens	Magnification	num. Apertur	nom. f-stop	eff. f-stop	Depth of field in mm
Mitutoyo M Plan Apo 2x	2:1	0,06	6,06	18,1	0,1994
Mitutoyo M Plan Apo 5x	5:1	0,14	2,98	17,9	0,0314
Mitutoyo M Plan Apo 5x HR	5:1	0,21	1,98	11,9	0,0225
Mitutoyo M Plan Apo 7,5x	7,5:1	0,21	2,10	17,9	0,0139
Mitutoyo M Plan Apo 10x	10:1	0,28	1,62	17,9	0,0078
Mitutoyo M Plan Apo 10x HR	10:1	0,42	1,08	11,9	0,0056
Mitutoyo M Plan Apo 20x	20:1	0,42	1,13	23,8	0,0023
Mitutoyo M Plan Apo 50x	50:1	0,55	0,89	45,4	0,0009
Mitutoyo M Plan Apo 50x HR	50:1	0,75	0,65	33,3	0,0003

Step Mode

For an alternative, more scientific method you use the Step Mode and first determine the depth of field, depending on the magnification, the f-stop and the maximum permissible circle of confusion. You can use this formula or a table calculated from it.

Strictly speaking, the formula on the right applies only to approximately symmetrical lenses with a pupil scale of approximately 1: 1, which is true for most macro lenses.

$$\Delta_d = 2 Z k \frac{1 + \beta}{\beta^2}$$

Δ_d = Depth of field

Z = Permissible circle of confusion

k = F-stop

β = Magnification

• Permissible circle of confusion Z

The still permissible circle of confusion diameter is usually estimated at 1/1500 of the film- or sensor diagonal of the camera. For the 35mm format with the diagonal of 43.2 mm, this results in a permissible circle diameter of 0.0288 mm. Smaller values can be used if the result is to be greatly increased. However, this requires a high-resolution camera.

• F-stop k

The f-stop is set on your camera or directly on the lens. Excessive apertures (high f-stops above 11) should be avoided because of the diffraction blurring that occurs with it.

• Magnification β

The magnification is the ratio between the image size and the real object size. To determine it, you must know the sensor size of your camera (the image size).

To have enough overlap between the different planes of sharpness, use only a fraction of the depth of field thus determined as step length. So divide the result for the depth of field (from the formula or table) e.g. with 4 and enter it under "Step in mm" in the SETTINGS menu.

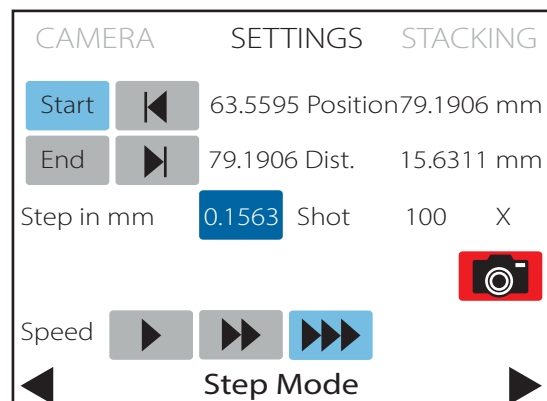

Determine start and end position as described above. The control unit then automatically calculates the total distance "Dist." and the number of shots "Shots".

After that, start the exposure series as described in the STACKING menu.

Cable connections

20	Power adapter 12V / 1500 mA (technical modifications reserved)
21	Connecting cable control unit / focusing rack type RJ45
22	Camera release cable (3pin / 2.5mm jack, not within the scope of delivery)

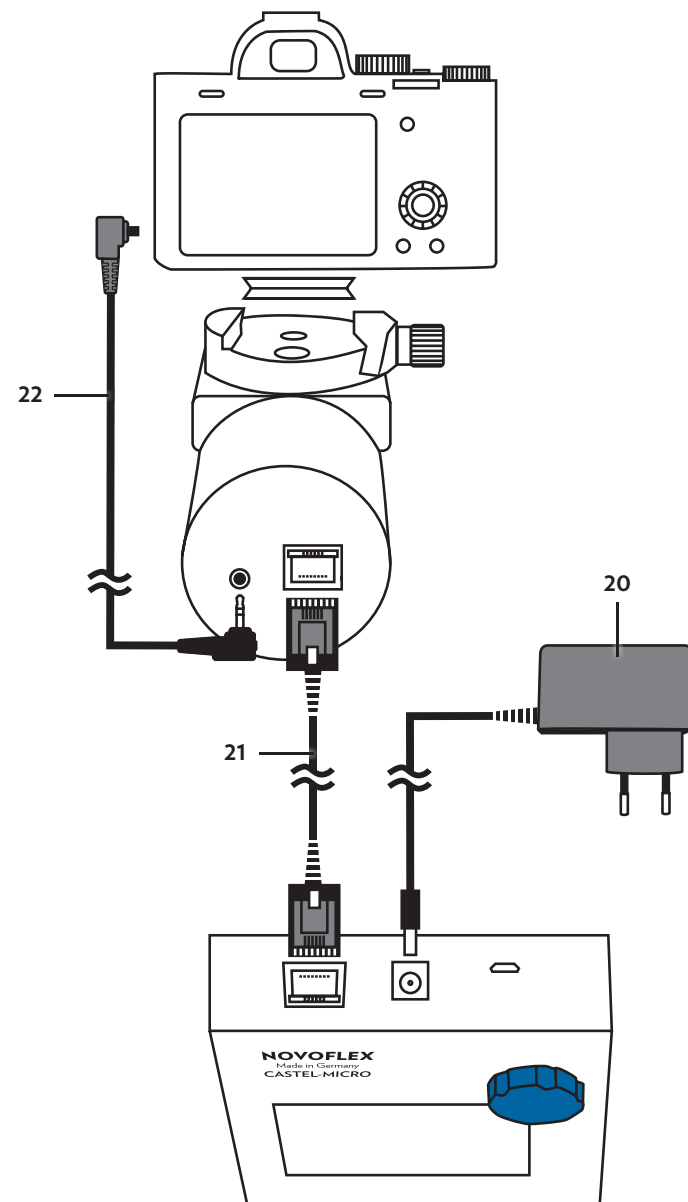



Product description

With increasing magnification in the near and macro range, one encounters the problem of decreasing depth of field. Objects are thus only sharply displayed in a small area, while foreground and background appear blurred. Using very closed aperture, which extends the depth of field, leads to diffraction and affects the quality of the recording considerably. In addition, the gain in depth of field is often not large enough.

Focus Stacking

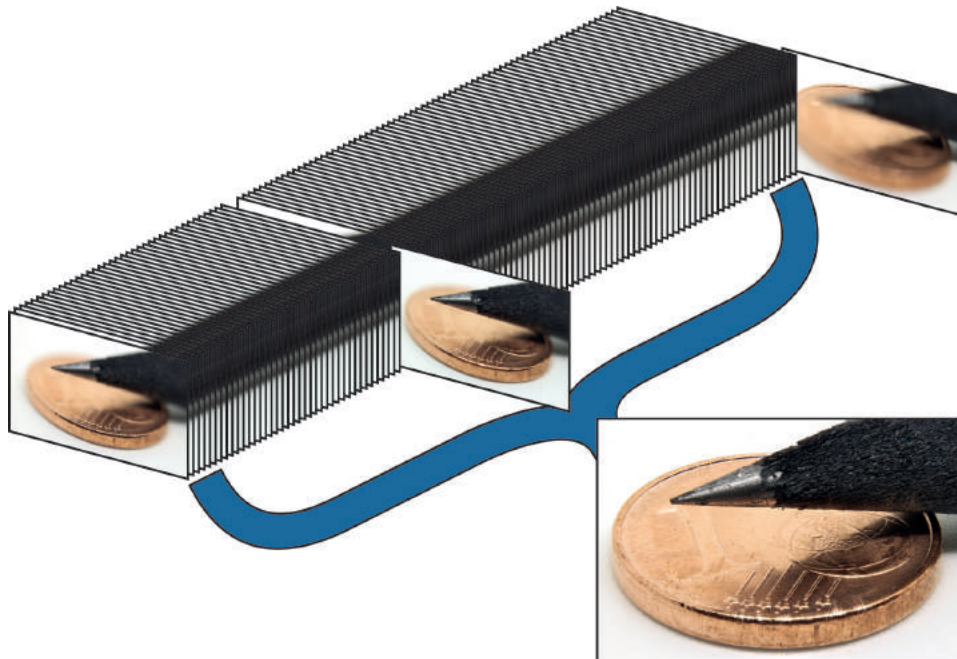
An ingenious solution to this problem is the focus stacking technique, which works with medium aperture or the so-called optimal aperture. Here, a larger number of shots are taken at different distances from the subject and different focus. The short focus area thus moves from shot to shot through the image. A software then calculates the individual images of shallow depth of field to form an overall image with a large depth of field.



Go to the STACKING menu, if necessary set a countdown and press the green button  to start stacking.

After that, the images can be processed with a stacking software such as Helicon Focus Pro, Zennere Stacker or Focus Projects Professional by Franzis to a picture with a large depth of field.

If the result contains blurred areas, increase the number of shots on the next try.



Fig. above: Result of the stack of 100 exposures at f-stop 8, magnification approx. 1: 1, step length 0.1563 mm, camera with APS-C sensor size and 50mm lens in retro-position (NOVOFLEX reverse adapter EOS-RETRO).

Workflow and recommendations

Ideal conditions for a successful stacking are a stable construction, a calm subject, constant light conditions and a constant exposure, meaning camera program M with constant shutter speed, f-stop and ISO setting.

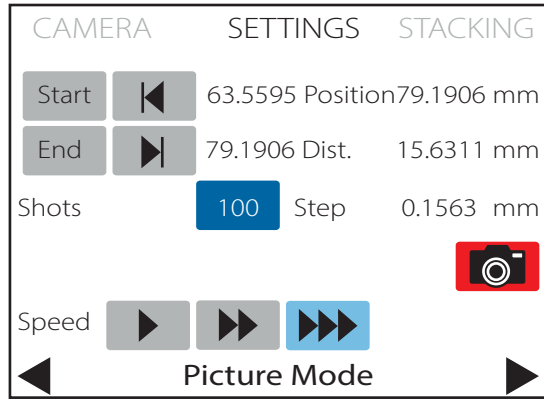

Fig. 1



Fig. 2

Picture Mode

For a fast stacking use Picture Mode. After selecting this mode in the main menu and making the CAMERA settings, switch to the SETTINGS menu.

Position the equipment so that the subject is still in the rear defocused area. Press the button **Start**, which then turns blue to set the start position.

Look through the viewfinder of your camera and use the **▶** button and fast speed **▶▶▶** to move forward to the position where you can see a sharp area in the viewfinder for the first time (Fig. 1). Confirm this position by pressing the button **Start** again.

Now press the **End** button to set the end position. Move through the focus area of your subject with the **▶** button to the point where no sharpness is recognizable (Fig. 2). Confirm this position as well.

Now press the blue “Shots” button **100** and enter the number of desired shots. In the field of macro photography this depends on the magnification, the f-stop used and the total distance, which is displayed below “Dist.” in mm. Generally, too many shots are usually unproblematic, too few already. So choose the number generously, e.g. 100 shots at 15 mm distance at f-stop 8 and a magnification of 1:1.

The electronically controlled focusing rack CASTEL-MICRO was developed for this purpose. After setting the start and end position, you can optionally program the step size (Step Mode) or the number of single shots (Picture Mode) as well as the waiting times before (Delay) and after each shot (Shutter Speed). Upon request, mirror lock-up is considered. After starting the program, the sliding block moves to the predetermined positions, where the control unit triggers the camera electronically. In Continuous mode, the sliding block does not stop and triggering occurs while driving. To avoid motion blur, short exposure times or flashlight is recommended when using this mode. The Bellows mode is designed for use with our optional CASTBAL-PRO bellows attachment. Here, the sliding block moves the camera tail to create a stack of differently focused images of the subject.

Technical data

The CASTEL-MICRO has a maximum adjustment travel of 100 mm (3.94 in) and a minimum repeatable step size of 0.2 micrometer. The maximum load for vertical installation is 4 kg (8.8 lbs). Thanks to its extremely precise guidance, the sliding block runs virtually free of play. In addition, the precision ball-bearing guide rails are characterized by consistent, high accuracy and a long service life.



CASTEL-MICRO with
MITUTOYO M-Plan Apo microscope lens

Safety instructions

Read these safety instructions carefully before putting the device into operation. Observe warnings and notes in this manual. If you sell or distribute this product, be sure to hand over this manual as well.

For power supply use only the power adapter (20) (within the scope of delivery) or two rechargeable batteries (19) type LP-E6 (not included, worldwide available). We recommend the use of original Canon batteries. **The batteries can not be charged with the control unit** (pictured right). Remove these when using the power adapter.

The RJ45 connections on the focusing rack and on the control unit **are not used to operate the devices within a network (LAN)**. They are only used for power and data transmission between these two devices. The supplied LAN connection cable (21) can be exchanged by a standard patch cable up to 3m in length and is available worldwide.

Protect the control unit and the focusing rack from moisture, sand and dust and **keep the electronic contacts and spindle (6) clean**.



Be aware that there is a risk of pinching during operation. Make sure that the routes to the front and rear are free of obstacles and that the camera cable (22) is long enough. For the initial calibration run of the sliding block (3) on the focusing rack it is necessary to leave the finger on the field "START" of the control unit. Pulling the finger back will stop the sliding block immediately. In later operation, the drive can be stopped by pressing the blue rotary knob (12) or the stop symbol  in the display. Alternatively remove the RJ45 connection cable (21) or the power adapter (20) of the control unit.

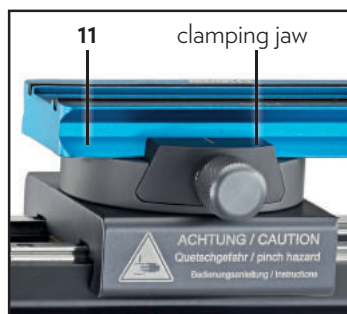

To mount the camera equipment on the quick release, tighten the clamping screw (4). Always make sure that **both clamping jaws of the quick release unit (5) engage in the profile of the camera plate (11)** to prevent slipping out of the equipment mounted on it.

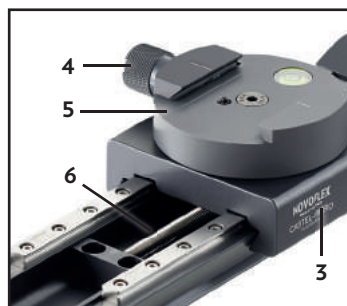

Please also note the illustrations for the nomenclature on pages 3, 4 and 5.







In addition, just as in the Continuous Mode already described, forward or reverse travel can be selected. To do this, press the double arrow , which then turns blue for reversing .

Tip: Before changing to the next "STACKING" menu, check again the "Speed" setting. This also affects the speed during stacking. Usually you can work relatively fast . Only at very large magnifications or unstable build, the slow speed is recommended .

Now switch to the "STACKING" menu with a pressure in the upper right corner.

STACKING

In the STACKING menu, you start and monitor the stacking process.



CAMERA	SETTINGS	STACKING
		Pos. 79.1906 mm
Count down	 5 sec	Delay 0 sec
Save Settings	 3	Shots 101
		Duration 8 min
		

Here you can set a delay using the **Countdown** button, if e.g. the shooting series should only begin when you have left the room yourself to avoid vibrations.

Use **Save Settings** to save the previous basic settings, if you want to use them more often. There are three memory slots available.

Use the green button  to start the stacking process.

The sliding block moves to the starting position and starts the shooting series.

With the red button  you can cancel the running stacking. The settings are retained. Press the green button  again to start a new stacking. The sliding block then returns to the starting position and begins a new series of shots.

The charge of the batteries is shown below as an icon . When battery 1 becomes low, it will automatically switch to the second battery. Then the first battery can be changed.

The right part of the display shows the current position "**Pos**", the current delay in seconds "**Delay**", the remaining number of shots "**Shots**" and the approximate remaining time "**Duration**" in minutes.

Stacking is over when the number 0 is displayed after "Shots".

You can now start the stacking again or make changes in the CAMERA, SETTINGS or in the main menu (by pressing the blue rotary knob).

Continuous Mode

If you are working in **Continuous Mode**, enter in the blue field “Time in sec” the wanted time and in the field “Shots” the number of shots to be taken during this time. The step length is automatically calculated and displayed under Step number mm. Here, e.g. 0.1563 mm as a result of 100 shots, which will be taken within 420 seconds. For invalid inputs, e.g. 100 shots in 10 sec., the time is automatically adjusted to the next possible value.

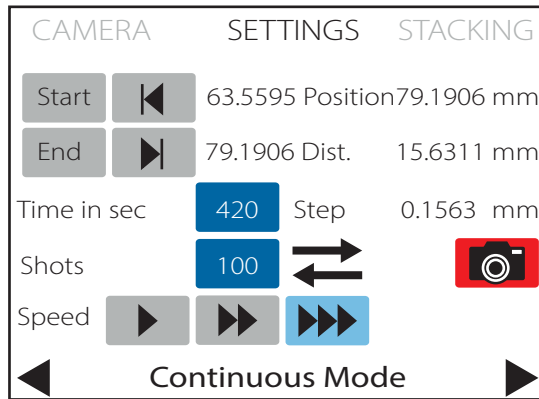

Bellows Mode

If you are working in **Bellows Mode**, enter in the blue fields either the number of shots “Shots” or the step “Step”. The other value is calculated automatically. If invalid values are entered, e.g. a step length which is larger than the set distance, the fields to be corrected are highlighted in red. Changing to the following menu STACKING is only possible after correcting these values.

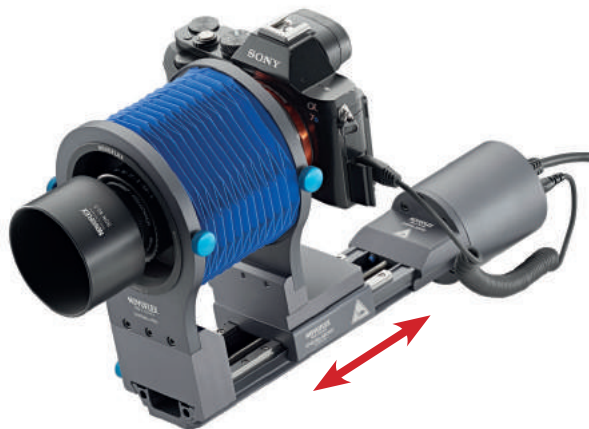
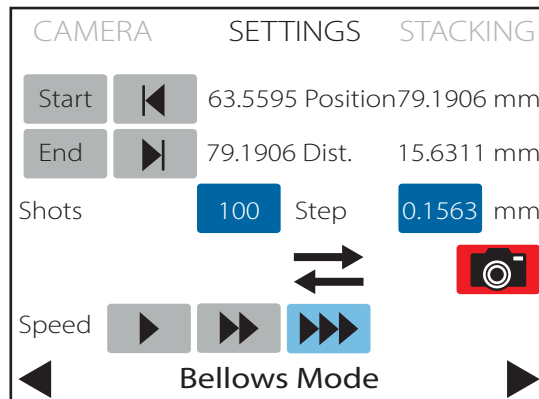

The Bellows Mode was also designed to be used with the optionally available bellows attachment CASTBAL-PRO (picture left).

Ideally, with a fixed lensboard, the camera back is moved. This allows a constant distance to the subject and thus a uniform perspective.

Preparations

Mount the focusing rack on a sturdy tripod (recommended: NOVOFLEX TrioPod), ball head (eg. NOVOFLEX ClassicBall 2) or tilting device. Use one of the two 3/8 “or 1/4” holes (10) on the bottom of the rack or use the dovetail guide, which fits into the upper slot of our Q=MOUNT and Q=BASE quick release units, which are ARCA Swiss-UniQ / C compatible. The safety pin of a NOVOFLEX quick-release unit attaches to the milling cut-out (9) and prevents unintentional slipping

is made with the help of the patch cable (21). Use the connection sockets on the back of the rack (2) and the upper edge of the control unit (15). The control unit has a 3/8 “drilling hole (14) with 1/4” adapter on the bottom for mounting on any ball head or tripod.

To mount the camera equipment on the focusing rack use the Q=MOUNT quick release unit (5) and a camera plate type Q=PLATE (11). These are available in different sizes, with different thread screws and with and without

anti-twist pins. Ideal are slightly longer plates such as the QPL3 or QPL4, as well as side-scale plates such as the QPL-PANORAMA, because you can roughly preset the focusing distance. An overview of all available exchangeable plates can be found on our website www.novoflex.com.

First mount the camera plate under your camera or lens collar. After that insert this unit into the quick release unit (5) of the rack. Make sure that both clamping jaws of quick release (5) engage in the profile of the camera plate (11) to prevent slipping out of



out of the rack if the corresponding clamping screw was accidentally not fully tightened. Using a quick-release unit below the focusing rack enables you to roughly preset the focusing distance by moving the rack forwards and backwards. The connection to the control unit

the equipment mounted on it. Then tighten the clamping screw (4) and check to ensure the mounted device is securely held on to the focusing rack.

Using a dedicated camera release cable (22), connect the focusing rack to the camera. Type-specific cables are available as accessories for all common camera systems from us.

Now set up the power supply to the control unit. To do this, use the supplied power adapter (20) or insert two LP-E6 rechargeable batteries (19) (not included) on the back of the control unit into the holder (18) provided for this purpose. The battery operation was designed for outdoor applications. Suitable LP-E6 batteries and associated chargers are available worldwide. Please note that the control unit does not charge the batteries. If the battery is low, it automatically switches to the other battery. The active battery and its charge status  are displayed in the calibration- and STACKING menu. The other battery can also be removed during operation, charged externally and replaced.

Now position the equipment at a suitable distance from the subject.

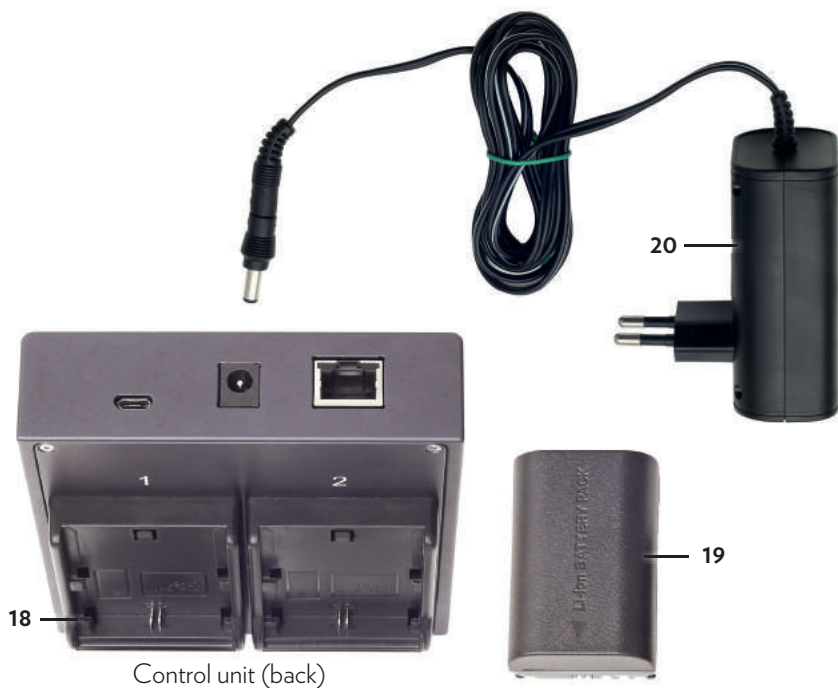

Setting up step length, number of shots, speed and direction

Depending on which mode you have chosen in the main menu, you can now change settings in the middle area regarding the step length, number of shots, speed and direction of the travel.

Tip: To change the mode, press the blue rotary knob (12). Modified settings are retained.

Step Mode

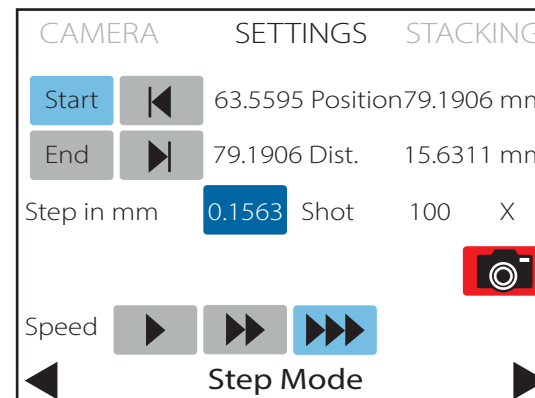

In **Step Mode** you specify the step length in the blue field "Step in mm". Here e.g. 0.1563 mm. The number of steps is then automatically calculated and displayed under Shot number X. Here e.g. 100.

The sliding block will move from the start towards to the end position.

The speed can be controlled in three stages with the help of the speed buttons.

Tip: The step length should be significantly less than the depth of field. The depth of field can be observed in the viewfinder with closed f-stop, calculated or determined using a table. More about this in the chapter "Workflow and recommendations".

Picture Mode

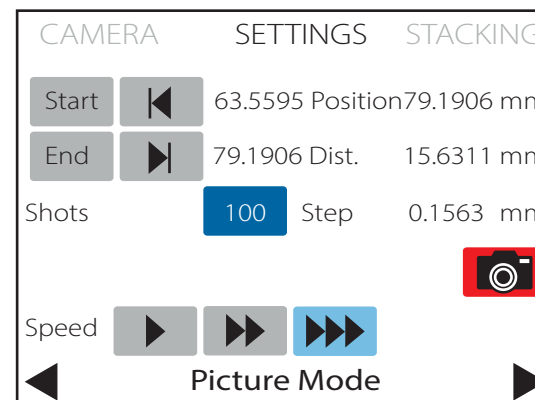

In **Picture Mode** you specify the number of shots in the blue field "Shots". Here e.g. 100 shots. The step length is then automatically calculated and displayed under Step number mm. Here e.g. 0.1563 mm.

The sliding block will move from the start towards to the end position.

The speed can be controlled in three stages with the help of the speed buttons.

Load Settings: Here, previously saved settings can be recalled. The settings are saved in the STACKING menu.

Use the red button  to trigger the camera for test purposes. If “Mirror up” is activated, it must be triggered twice.

Pressing “SETTINGS” in the upper bar will take you to the settings menu:

SETTINGS

Here, regardless of the selected mode, you first determine the start and end position of the stack.

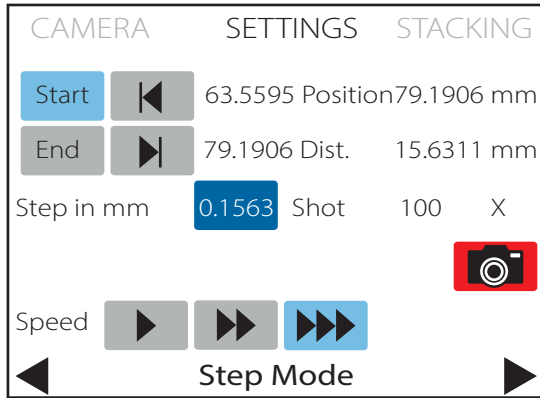



In the upper area, the selected start and end position, the current position (“Position”) and the driving distance (“Dist.”) are displayed.

The picture on the left shows a screenshot from Step Mode. The display in the other modes is the same, except for the middle section.



Setting up start and end position



Press the button  - this now changes the color to light blue .



In order to move the sliding block to the start position use the button “left”  (back) or right  (forward) in the lower area of the display. The speed can be adjusted via the three “speed” buttons e.g.  in the lower area.

The “speed” setting also affects the speed during stacking. For critical subjects (high magnification or instable build), you should drive at slower  speeds, otherwise you can work faster .

The fine adjustment of the position can also be done via the blue rotary knob (12). The maximum step length when setting via the knob (12) is limited to 5mm.

If the start position is determined, press the  button and determine the end position as described above. The button  will turn blue, the button  gray again.

With the help of the two buttons  and  you can now, for example, drive directly to the start or end position for checking. While driving, the respective buttons are displayed in blue.

Press  or  again, to overwrite the current position as start or end position.

Operation

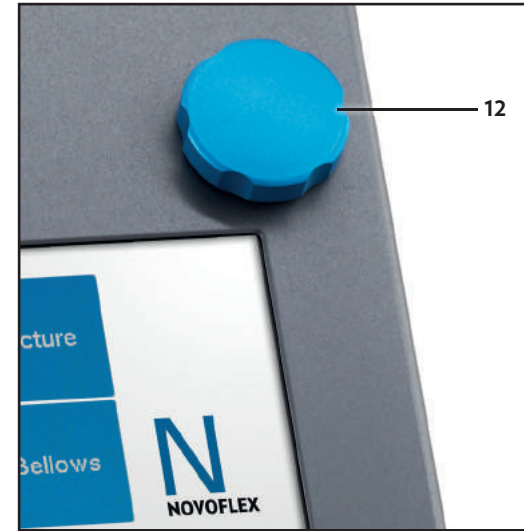

Switching on and off

The device is switched on and off by pressing and holding the blue rotary knob (12), until the display turns on or off.



Calibration

After switching on, a calibration run is necessary.

The sliding block moves slowly back to the end-stop.

To do this, press and hold the blue area of the touchscreen labeled “Start” until the message “Calibration” appears with a check behind it.



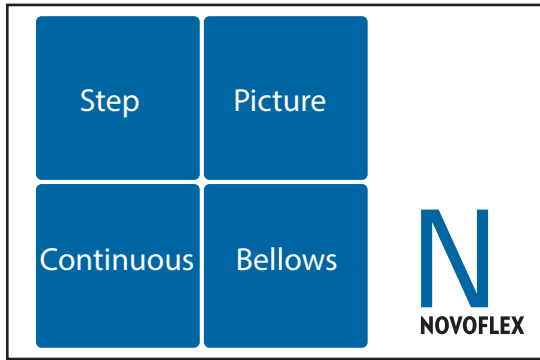

Main Menu

Now open the main menu. Here, you can switch between the modes.

Tip: A short press on the blue rotary knob (12) will take you straight to the main menu, no matter which submenu you are currently in.

Modes

In all modes speed, pauses, as well as the start and end position of the shooting series, the so-called “stacks” are determined. Depending on the specification, the respective program independently calculates the necessary distance between two shots or the number of shots and displays this value as well as the length of the journey on the display. Then the automatic stacking can be started.

The following modes are available:

• Step Mode

Here you specify the distance between two exposures. You can determine this by using a table or formula (more in the “Workflow and recommendations” section). The device then automatically determines the number of shots between start and end position.

• Picture Mode

Here you specify the number of shots between the start and end position. The device then calculates the distance in mm between two shots. This is a quick and easy method, in which you should select too much rather than too few exposures.

• Continuous Mode

This mode is available for special applications in which the sliding block moves continuously, eliminating the otherwise necessary acceleration and braking distances and the associated waiting times. The exposures should therefore be done with very short shutter speeds and/or flashlight. By default, enter the travel time and the number of shots you want to take during that time. The step length is automatically calculated. You can choose between forward and reverse travel.

• Bellows Mode

Here you can enter either the number of shots or the distance between two shots. The other value is determined automatically. In addition, it is possible to switch between forward and reverse travel. This mode is very flexible and suitable for a variety of applications, e.g. with our bellows attachment CASTBAL-PRO.

CAMERA

In each mode you first get to the “CAMERA” settings.

CAMERA	SETTINGS	STACKING
Delay	2 sec	
Mirror up	✓	
Shutter Speed	4 sec	
Delay Mup	5 sec	
Load Settings	3	

Delay indicates the waiting time before the exposure. By tapping on the blue field you get to a submenu in which you can change the corresponding time. The “DEL” key deletes the last digit, the “CLR” key deletes the entire input field, the “Cancel” key sets the waiting time with the default value of 2 seconds, “OK” saves the entered time and terminates the submenu exactly like “Cancel”.

Mirror up takes into account the mirror lock function of the camera. Important:

You must also set this on the camera. If this function is activated on the control unit, an initial pulse is sent to the camera before triggering, which raises the mirror.

Tip: If your camera has a “Live-View” function, we recommend using it instead of the “Mirror up” function described above, since the Live-View operation protects the mirror mechanism of your camera and is very low in vibration. In the menu, “Mirror up” should be deactivated and the camera put in the Live-View state before stacking.

Delay Mup appears only when “Mirror up” is selected and indicates the delay between the mirror pulse and exposure pulse. Touch the blue box to go to a submenu where you can change the time. The default value is 5 seconds.

Shutter Speed is used to calculate the waiting time after exposure. Select the shutter speed set on the camera here. The system then calculates the corresponding waiting time. The setting is made via the blue rotary knob (12).

