

Godox

V100

TTL 锂电圆头机顶闪光灯

TTL Li-ion Round Head Camera Flash

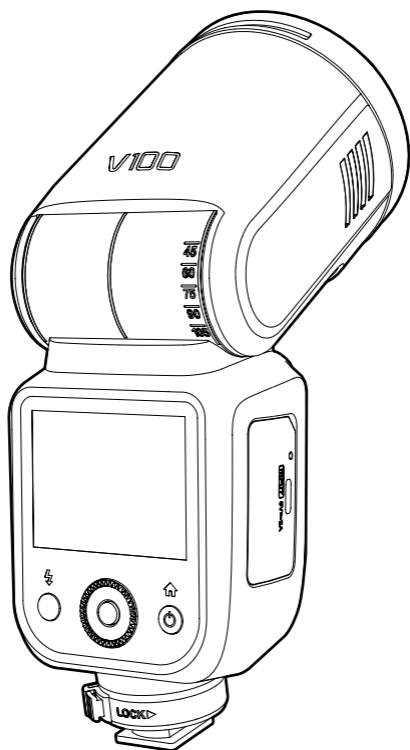

使用手册

Instruction Manual

目录

- 01 关于本手册
- 02 重要的安全说明及注意事项
- 04 前言
- 05 部件名称
 - 机身
 - 分体式副闪光灯 SU-1
 - 2.3 寸触控彩屏
- 06 物品清单
- 06 可选购附件
- 07 装卸电池
- 07 电池电量指示
- 08 安装闪光灯 / 拆卸闪光灯
- 08 安装 / 拆卸分体式副闪光灯 SU-1
- 09 电源管理
- 10 机顶模式
 - M: 手动闪光模式
 - TTL: TTL 自动闪光模式
 - 变焦: 设置闪光灯覆盖范围
 - 副灯: 分体式副闪光灯 SU-1
- 12 主控模式
 - 组别
 - M 手动闪光—闪光功率
 - TTL 自动闪光—闪光曝光补偿量
 - 全组参数统一调节
 - 变焦: 设置闪光灯覆盖范围
- 13 从属模式
 - 组别
 - TTL: TTL 自动闪光模式
 - M: 手动闪光模式
 - 闪光功率设置
 - 变焦: 设置闪光灯覆盖范围
- 14 其他功能
 - 同步方式
 - 自动辅助对焦灯
 - 光控引闪 (V100 O)
 - 蜂鸣器设置
 - 造型灯设置
 - 屏幕锁定
 - 频闪闪光
- 17 无线设置
 - 扫描空闲频道
 - 频道设置
 - 识别号设置
 - 无线同步
- 18 菜单设置
- 19 无线闪光拍摄 (2.4G 无线传输)
- 20 无线主控 / 从属设置
- 20 关于主控单元
- 20 主控单位(闪光灯)闪光开 / 关 (仅 V100 C 具备此功能)
- 21 TTL: 全自动无线闪光拍摄
- 23 M 手动闪光的无线 (多重闪光) 拍摄
- 23  频闪闪光的无线 (多重闪光) 拍摄
- 24 其他应用
 - 同步插孔触发

	造型闪光
	反射闪光
	电池电量低警示
25	用相机菜单控制闪光灯 (仅 V100 C 具备此功能)
26	全域快门同步拍摄 (仅 V100 S 具备此功能)
27	保护功能
28	神牛 2.4G 无线漏闪原因及解决办法
29	规格参数
30	故障排除指南
30	固件升级
31	兼容相机列表

关于本手册

本手册操作说明假定相机和机顶闪光灯的电源开关已开启。

本手册中，▲ 此图标所列事项是为避免产生拍摄问题，您需要注意的事项，❶ 此图标所列信息是文中某项功能的补充信息。

重要的安全说明及注意事项

本产品属于专业摄影设备，需要专业人员操作使用。

使用前必须拆除产品上的所有运输保护材料和包装。

使用时必须遵守以下基本安全预防措施：

1. 使用本产品前，请仔细阅读并完全理解产品说明书，严格按照说明书中的安全提示操作。否则，可能导致死亡、严重伤害、产品损坏或其他财产损失的安全隐患。
2. 本产品为专业灯具，儿童禁止使用。儿童接近时，成人必须密切监督，防止儿童碰撞灯具或私自使用灯具，造成人身伤害。
3. 本灯具并非普通灯具，不可用于普通照明，任何有过眼部损伤或眼部敏感的人群均应避免使用本灯具或直视本灯具。
4. 使用时必须小心，严禁接触如闪光管等高温部件，以避免烫伤。
5. 任何情况下均禁止将闪光灯直接对准人眼（特别是婴儿眼睛），否则短时间内可能导致视力损伤。如感到眼睛不适，应立即关闭灯具，停止使用并及时就医。
6. 严禁使用损坏的设备或配件，必须等待专业维修人员检查维修并确认设备正常后，才可继续使用。
7. 使用过程中，如果产品因跌落、挤压或强力冲击导致外壳破裂，应立即停止使用，避免接触内部电子部件而触电受伤。
8. 本设备不防水，请保持干燥，不能浸入水或其他液体；应安装在通风干燥位置，避免在雨天、潮湿、多尘或过热环境中使用。不要在设备上方放置物品，或让液体流入内部，防止发生危险。
9. 未经授权，请不要自行拆卸本产品。产品若出现故障，必须由本公司或授权维修人员检查和维修。
10. 存放设备前，请确保设备已完全冷却。
11. 请勿将设备放置在酒精、汽油等易燃挥发性溶剂或气体如甲烷、乙烷等附近。
12. 本设备禁止在有爆炸危险的环境中使用或存放。
13. 运行期间和之后，设备灯头与用户和其他人员，以及热敏或可燃物品之间，距离必须始终保持至少 1 米。
14. 请勿使用未经本公司认可的配件，以免造成火灾、触电或人身伤害。
15. 清洁设备时，请用干燥软布轻轻擦拭，不可使用湿布，否则可能会损坏设备。
16. 本使用说明基于严格测试制定，设计和规格变更恕不另行通知。您可登录我们官方网站查看最新电子版使用说明，了解产品最新资讯。
17. 产品使用锂电池供电。这类锂离子电池使用寿命有限，会逐渐失去储电能力，这种能力下降不可逆。电池老化时，产品续航时间会减少。锂离子电池使用寿命预计 2—3 年。请定期检查电池情况，如果充电时间明显增加或续航时间明显减少，请考虑更换新电池。
18. 产品配备锂电池，其储存建议如下： 储存前，将电池充放电至约 50% 电量；至少每 6 个月充电一次，至约 50% 电量；可拆卸电池应单独存放；储存温度在 0°C 至 40°C 范围内。
19. 使用锂电池的注意事项：
 - 不要拆卸、压碎或刺穿电池；
 - 电池没有防水功能，不要把电池浸泡在雾、水中；
 - 避免使电池触点短路；
 - 电池不要靠近和放置于火中；
 - 不要将电池暴露在 60°C 以上高温下；
 - 将电池放在儿童接触不到的位置；
 - 防止电池遭受过度冲击或振动；
 - 不要使用已损坏的电池；
 - 如果电池出现泄漏，请避免接触泄漏液体；
 - 如果眼睛接触电池液体，立即用水冲洗至少 15 分钟，抬起眼睑直到没有液体的迹象后及时就医。
20. 处理任何电池前，请确认并遵守当地相关法律法规。

21. 本设备整机的保修期为一年。消耗品（如电池）、适配器、电源线等配件不在保修范围内。
22. 私自维修将取消保修资格，需支付维修费用。
23. 请收到锂电池时及时检查电池状态、电量情况，如有任何质量问题及时在保修期内联系神牛或神牛所授权的经销商。
24. 不当操作导致故障不在保修范围。

前言

感谢您购买神牛产品。

触控屏圆头闪光灯— V100，以其卓越的兼容性，完美贴合 TTL 自动闪光技术。采用此闪光灯，即便是面对光线环境的频繁变换，您也能享受到前所未有的拍摄便利。此系列闪光灯具有以下核心特点：

快速操控：2.3 英寸触控彩屏和物理按键双重操作选择，直观易用。

高速连拍 (V100 S)：与全域快门相机无缝协作，突破闪光同步速度限制。

圆头透镜设计：圆头设计，提供均匀、柔和的补光效果。

强劲闪光性能：100Ws 闪光功率，81 级功率调节，满足各种拍摄需求。

LED 造型灯：内置 LED 造型灯，亮度可调，方便预先观察光影效果。

高效电源：配备 7.2V / 2980mAh 锂电池，全功率闪光 400 次，回电速度快 (1.7s)。

TTL 兼容：支持 TTL 自动闪光，简化操作流程。

无线功能：内置 2.4G 无线引闪，扩展拍摄可能性。

扩展配件：支持外接电源盒 (PB960, 需另购)，提升拍摄效率；支持 SU-1 副闪光灯。

专业功能：支持手动闪光、频闪、高速同步、后帘同步、闪光曝光补偿等。

稳定输出：保证高速连拍时，闪光输出的色彩和亮度一致。

固件升级：定期更新固件，兼容最新的相机型号，确保最佳性能。

兼容性：V100 C 适用于佳能相机，V100 S 适用于索尼相机，V100 N 适用于尼康相机，V100 O 适用于奥林巴斯 / 松下相机，V100 F 适用于富士相机。

注：闪光灯电源盒 PB960 需另购。

部件名称

机身

1. 闪光灯头
2. LED 造型灯
3. 外置闪光灯接口
(可安装 SU-1 副灯等附件)
4. 无线传感器
5. 辅助对焦灯
6. 外接电源盒接口
(用于连接 PB960 电源盒, 电源盒需另购)
7. 反射角度刻度
8. 电池充电指示灯
(充电时指示灯变红, 充满变绿)
9. USB Type-C 充电接口
(用于电池充电)
10. 锂电池
11. 触控彩屏
12. 电源按键
(短按一次进入模式 / 返回模式界面, 短按两次, 其他功能界面出现。)
13. 热靴
14. 固定热靴扣钮
15. 试闪按键 / 回电指示灯
16. 调节拨轮
17. 设置按键
(短按选中某项或确认某项)
18. 同步插孔
19. USB-C 固件升级接口
(用于机器升级固件)
20. 电池释放按钮

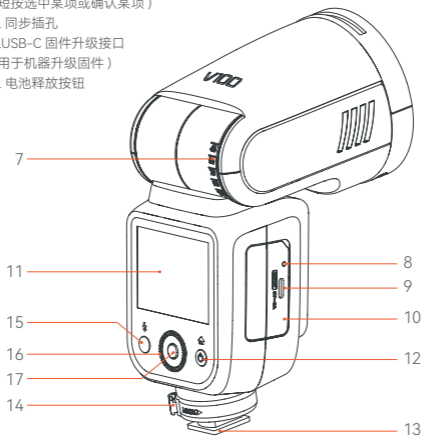
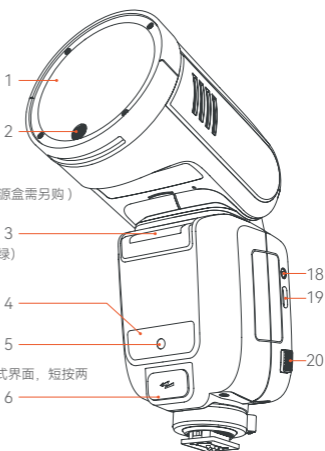

分体式副闪光灯 SU-1

1. 灯管
2. 拆卸推制

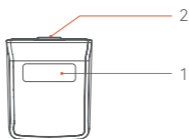

2.3 寸触控彩屏

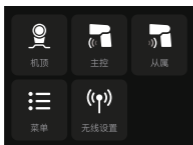

模式界面

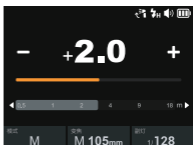

机顶模式

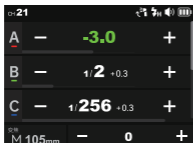

主控模式

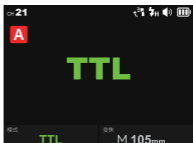

从属模式

(展示界面为 V100 C 主控界面, 其他型号界面有所区别)



其他功能界面

(V100 O 无对焦辅助灯显示)

物品清单



灯体
×1



收纳包
×1



充电器
×1



微型底座
×1



USB Type-C
充电线 ×1



锂电池
×1



分体式副闪光
灯 SU-1 ×1



说明书
×1

可选购附件

您可另购本公司以下摄影附件, 以获得最佳的拍摄效果和使用体验。



引闪器 X2T 系列



引闪器 XProII 系列



引闪器 X3 系列

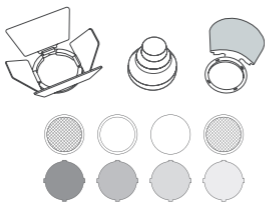

AK-R1 圆形灯头附件套装

注：根据所购闪光灯机型，购买对应的附件型号，请勿错误购买。

装卸电池

拆卸电池： 按住电池释放按钮，然后推出电池。

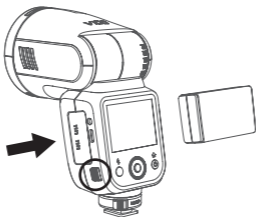

安装电池： 将电池依照电池仓内的指示方向插入。直至电池卡入到位。

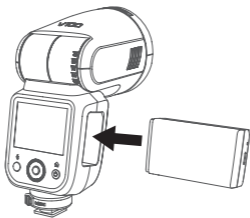

电池电量指示

将锂电池正确安装在闪光灯上，即可给闪光灯供电。使用时请查看闪光灯屏幕上电池图标，即可随时掌握电量状态。

电池电量显示	说明
3 格	满电
2 格	中电
1 格	低电
无格	电量少，请及时充电
全屏显示低电符号	电量即将用尽，此状态不支持闪光灯工作。 注：此状态请尽快（10 天内）充电，才可使用或放置。

安装闪光灯 / 拆卸闪光灯

安装：按住固定热靴扣钮的同时旋转到左边，即可插入相机热靴，随即转动闪光灯锁环到右边便可锁定热靴。

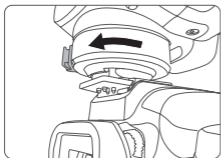

拆卸：按住固定热靴扣钮的同时旋转到左边，即可解锁热靴，此时取下闪光灯完成拆卸。

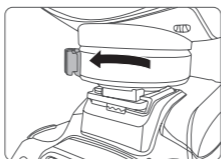

▲ 请务必在安装和拆卸闪光灯时，关闭相机和闪光灯的电源，以防止损坏设备。

安装 / 拆卸分体式副闪光灯 SU-1

安装：您只需将分体式副闪光灯 SU-1 对准机顶闪光灯 V100 外接闪光灯接口平行卡入后下压，听到“咔”一声即可安装完成。

拆卸：您推动分体式副闪光灯拆卸推制的同时，往上取出即可拆卸完成。

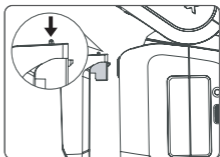
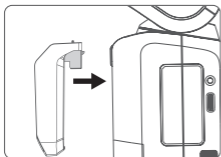

▲ 请先关闭闪光灯 V100 的电源，再进行 SU-1 副闪光灯的安裝和拆卸操作。主灯电源开启或工作状态下切勿强行插入或拔出 SU-1 副闪光灯，以免造成 SU-1 的损坏。

电源管理

开机：长按电源按键直至屏幕出现 < SET > 图标，您可跟着箭头方向轻触屏幕开机或顺时针拨动调节拨轮开机。

注意：开机后若 15 秒内无操作，屏幕背光将自动熄灭，轻触屏幕即可重新点亮。



休眠：

处于机顶模式 / 主控模式且开启待机后，若长时间无操作（约 90 秒），闪光灯将自动休眠。可通过半按快门或触碰机身任意键唤醒。

自动关机：

机顶 / 主控模式：待机关闭且自动关机功能开启。若超过 60 分钟（可调至 30 或 90 分钟）无操作后，闪光灯自动关机。

从属模式：自动关机功能开启，若超过 60 分钟（可调至 30 或 90 分钟）无操作后，闪光灯自动关机。离机使用时，支持手动关闭自动关机功能。

机顶模式

触控使用: 从屏幕左边往右滑动, 屏幕出现模式界面。轻触屏幕上“机顶”图标, 进入机顶模式主界面。

拨轮与按键使用: 短按电源按键, 屏幕出现模式界面。旋转调节拨轮选中“机顶”图标, 短按设置按键进入机顶模式主界面。

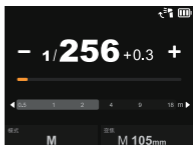
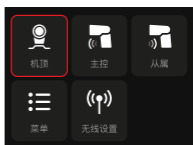

M: 手动闪光模式

您可以在 1/256~1/1 或 2.0~10 之间以 0.1 档或 0.3 档为增量设置闪光输出。为获得正确的闪光曝光, 请使用手持的闪光测光表确定所需的闪光输出。

触控使用: 轻触模式图标可切换 M 模式, 您可点击屏幕的一图标或 + 图标, 进行 ± 0.1 档或 ± 0.3 档精确调节, 或拉动黄色进度条进行快速调节。

拨轮与按键使用: 旋转调节拨轮选中模式”图标, 短按设置按键进入模式设置, 旋转调节拨轮选择 M 模式, 选好短按设置按键退出。旋转调节拨轮选中功率范围, 短按设置按键进入功率范围调节, 旋转调节拨轮进行 ± 0.1 档或 ± 0.3 档精确调节, 您也可快速转动调节拨轮进行快调。

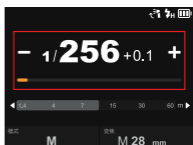

S1 光控单元设置: 在 M 手动闪光模式下, 可以使用 S1 功能, 闪光灯可作为副灯使用, 创造多种照明效果, 适用于手动闪光环境。它会与主闪光灯的第一次闪光同步触发闪光, 效果与使用无线引闪器一致。

S2 光控单元设置: 在 M 手动闪光模式下, 可以使用 S2 功能, 闪光灯可作为副灯使用, 适用于 TTL 闪光环境; 具有防预闪功能, 使用带一次预闪功能的相机能用光控实现同步拍摄。它会与主闪光灯的第二次闪光同步触发闪光, 即 2 次光控引闪。

- ▲ 1. 只有在 M 模式下才支持 S1/S2 光控引闪。
- 2. 您可前往菜单设置, 可切换 S1 光控或 S2 光控或关闭此功能。
- 3. 当您使用的是 V100 O 机型, 可在其他功能界面找到光控引闪, 可开启或关闭。

TTL: TTL 自动闪光模式

在 TTL 模式下, 相机的测光系统会侦查从主体反射回来的闪光照明, 从而自动调节闪光输出量, 使主体和背景得到均衡曝光。

触控使用: 轻触模式图标可切换 TTL 模式, 您可点击屏幕的一图标或 + 图标, 在 ± 3 档间进行 $\pm 1/3$ 精确调节闪光曝光补偿量, 或拉动黄色进度条进行快速调节闪光曝光补偿量。

拨轮与按键使用: 旋转调节拨轮选中模式”图标, 短按设置按键进入模式设置, 旋转调节拨轮选择 TTL 模式, 选好短按设置按键退出。旋转调节拨轮选中闪光曝光补偿量范围, 短按设置按键进入闪光曝光补偿量调节, 旋转调节拨轮在 ± 3 档间进行 $\pm 1/3$ 精确调节, 您也可快速转动调节拨轮进行快调。

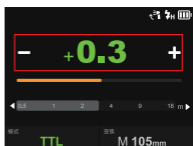

- 半按相机快门按钮进行对焦，有效闪光范围将会显示在显示屏上。
- 在快门释放前的瞬间进行一次预闪，闪光灯接收相机信息进行主闪光。

变焦：设置闪光灯覆盖范围。

该闪光灯有两种变焦方式：自动变焦和手动变焦。自动变焦时，焦距会随相机变焦镜头的改变而变化，以提供最佳闪光效果。

自动变焦：

A-mm，此状态下，闪光灯将自动设置闪光覆盖范围。

手动变焦：

28mm-105mm(V100 C/V100 S/V100 N)

28mm-105mm 或 14-52mm(V100 O)

28mm-105mm 或 18-69mm(V100 F)

触控使用：轻触“变焦”图标进入变焦设置界面，您可轻触屏幕选择自动变焦 A--mm 或手动变焦。

拨轮与按键使用：旋转调节拨轮选中“变焦”图标，短按设置按键进入变焦设置，旋转调节拨轮选择自动变焦或所需焦距，选好短按设置按键退出。

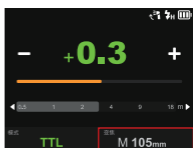

- ▲ 如果手动设置闪光覆盖范围，确保其覆盖镜头焦距，这样照片就不会出现阴影边缘。

副灯：分体式副闪光灯 SU-1

使用分体式副闪光灯 SU-1，可以在 M 档手动闪光输出 / TTL 自动闪光输出时，给予物体更好的补光效果，此功能常用于人像拍摄。

使用步骤：您只需将分体式副闪光灯 SU-1 对准机顶闪光灯 V100 外接闪光灯接口平行卡入，听到“咔”一声即可安装完成。

分体式副闪光灯 SU-1 闪光功率范围： 1/128-1/1 或 3.0~10，共 8 档，每档以 + 1/3 档为增量调节。

触控使用：轻触“副灯”图标进入副灯设置界面，您可轻触“-”或“+”图标调节功率，也可以拉动进度条快速调节功率。您还可轻触界面下面开关按钮，开启或关闭副灯。

拨轮与按键使用：旋转调节拨轮选中“副灯”图标，短按设置按键进入副灯设置，旋转调节拨轮选择所需闪光功率 / 关闭 (OFF)，选好短按设置按键退出。

- ▲ 1. 安装或拆卸前，务必关闭闪光灯电源。
- 2. 处于主控或从属模式时不能使用外接闪光灯 SU-1。
- 3. 闪光灯灯头需抬起，外置闪光灯方可正常使用。
- 4. 外挂闪光灯不支持高速闪光。

主控模式

触控使用：从屏幕左边往右滑动，屏幕出现模式界面。轻触屏幕上“主控”图标，进入主控模式主界面，往下滑动可查看更多组别。

拨轮与按键使用：短按电源按键，屏幕出现模式界面。旋转调节拨轮选中“主控”图标，短按设置按键进入主控模式主界面，旋转调节拨轮可查看更多组别。

当处于主控模式时，无线默认开启。

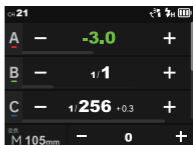
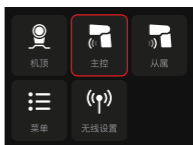

组别：

五组组别：

A 组、B 组、C 组、D 组、E 组 (V100 C)。

M 组、A 组、B 组、C 组、D 组 (V100 S、V100 N、V100 O、V100 F)。

M 手动闪光 - 闪光功率

触控使用：长按组框切换 M 手动闪光 /TTL 自动闪光 /OFF，此组框值若在 1/256-1/1 或 2.0~10 之间，当前组为 M 档手动闪光模式，此值为闪光功率值。您可轻触一图标或 + 图标调节闪光功率，或拉动组框底部进度条快速调节闪光功率。

拨轮与按键使用：旋转调节拨轮选中某组组别，短按设置按键进入设置，长按设置按键切换 M 手动闪光或 TTL 自动闪光 /OFF，此组框值若在 1/256-1/1 或 2.0~10 之间，当前组为 M 档手动闪光模式，此值为闪光功率值。旋转调节拨轮可选择功率，设置完毕短按设置按键退出。

TTL 自动闪光 - 闪光曝光补偿量

触控使用：长按组框切换 M 手动闪光 /TTL 自动闪光 /OFF，此组框值若在 -3.0~+3.0 间，当前组为 TTL 自动闪光模式，此值为闪光曝光补偿量。您可轻触一图标或 + 图标调节闪光曝光补偿量，或拉动组框底部进度条快速调节闪光曝光补偿量。

拨轮与按键使用：旋转调节拨轮选中组框，短按设置按键进入设置，长按设置按键切换 M 手动闪光或 TTL 自动闪光 /OFF，此组框值若在 -3.0~+3.0 间，当前组为 TTL 自动闪光模式，此值为闪光曝光补偿量。旋转调节拨轮选择闪光曝光补偿量，设置完毕短按设置按键退出。

全组参数统一调节

触控使用：您可轻触 - 图标或 + 图标统一调节闪光功率或闪光曝光补偿量。

拨轮与按键使用：旋转调节拨轮选中组框，短按设置按键进入统一调节设置，旋转调节拨轮统一调节闪光功率或闪光曝光补偿量。设置完毕短按设置按键退出。

变焦：设置闪光灯覆盖范围

您可选自动变焦和手动变焦 28mm-105mm（更多关于变焦的详细介绍可查看机顶模式中的变焦设置）。

从属模式

触控使用：从屏幕左边往右滑动，屏幕出现模式界面。轻触屏幕上“从属”图标，进入从属模式主界面。

拨轮与按键使用：短按电源按键，屏幕出现模式界面。旋转调节拨轮选中“从属”图标，短按设置按键进入从属模式主界面。

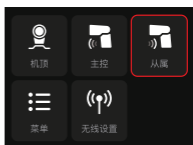

当处于从属模式时，无线默认开启。

组别

当前从属模式组别，可选范围：A、B、C、D、E。

触控使用：轻触屏幕的组别图标进入组别设置界面，轻触所需组别即可切换。

拨轮与按键使用：旋转调节拨轮选中组别图标，短按设置按键进入组别设置，旋转调节拨轮可切换组别，设置完毕短按设置按键退出。

TTL: TTL 自动闪光模式

触控使用：轻触模式图标可切换 TTL 模式。

拨轮与按键使用：旋转调节拨轮选中“模式”图标，短按设置按键进入模式设置，旋转调节拨轮选择 TTL 模式，选好短按设置按键退出。

更多 TTL 自动闪光相关内容可参考机顶模式主界面→TTL 自动闪光模式章节。

M: 手动闪光模式

触控使用：轻触模式图标可切换 M 模式。

拨轮与按键使用：旋转调节拨轮选中“模式”图标，短按设置按键进入模式设置，旋转调节拨轮选择 M 模式，选好短按设置按键退出。

更多 M 手动闪光相关内容可参考机顶模式主界面→M 手动闪光模式章节。

闪光功率设置

当模式选择 M 手动闪光，组框参数可设置，调节范围：1/256-1/1 或 2.0~10。

触控使用：您可轻触一图标或 + 图标调节闪光功率，或拉动组框底部进度条快速调节闪光功率。

拨轮与按键使用：旋转调节拨轮选中功率框，短按设置按键进入功率调节设置，旋转调节拨轮选择功率，设置完毕短按设置按键退出。

变焦：设置闪光灯覆盖范围

您可选自动变焦和手动变焦 28mm-105mm（更多关于变焦的详细介绍可查看机顶模式中的变焦设置）。

其他功能

处于机顶 / 主控 / 从属模式界面时，从屏幕顶部往下滑动，其他功能出现，设置完毕，从下往上滑动返回上一级。

处于机顶 / 主控 / 从属模式界面时，短按两次电源按键，其他功能出现，设置完毕，短按电源按键返回上一级。



(V100 C/S/N/F 界面)



(V100 O 界面)

同步方式

⚡H 高速同步

使用高速同步 (FP 闪光)，您可以在任意快门速度下同步使用闪光灯。高速同步闪光在使用光圈优先对人像进行填充时，闪光时特别方便。

🔙 后帘同步

使用慢速快门和后帘同步，您可以在被摄体后创建一条光线轨迹，在快门关闭前的瞬间闪光。

触控使用：轻触屏幕的“同步”图标可切换同步方式 (V100 C)。当机型为 V100 S 或 V100 O 或 V100 F 或机型为 V100N 但不连接尼康相机时，轻触屏幕“同步”仅开启或关闭高速同步，后帘同步需在相机上设置。

拨轮与按键使用：旋转调节拨轮选中“同步”图标，短按设置按键切换同步方式 (V100 C)。当机型为 V100 S 或 V100 O 或 V100 F 或机型为 V100N 但不连接尼康相机时，短按设置按键仅开启或关闭高速同步，后帘同步需在相机上设置。

注意事项：当你使用 V100 N 闪光灯且连接尼康相机，尼康相机快门设为高速快门时，闪光灯自动开启高速同步，当快门转为低速时，闪光灯自动关闭高速同步。

☹️ 自动辅助对焦灯 (V100 O 无此功能)

在低亮度或低对比度的拍摄情况下，闪光灯内置的自动对焦辅助灯将开启，使自动对焦更容易。当对焦困难时，红色辅助对焦灯亮起；当对焦准确，辅助对焦灯自动熄灭。

触控使用：轻触屏幕的“对焦灯”图标可开启或关闭。

拨轮与按键使用：旋转调节拨轮选中“对焦灯”图标，短按设置按键可开启或关闭。

位置	有效范围
中央	0.6~10 米 / 2.0~32.8 英尺
边缘	0.6~5 米 / 2.0~16.4 英尺

📌 用户在使用时，如发现辅助对焦灯未亮起，是因为相机已经处于准确对焦状态。

光控引闪 (V100 O)

触控使用：轻触“光控”图标切换 OFF/S1/S2。

拨轮与按键使用：旋转调节波轮选中“光控”图标，短按设置按键切换 OFF/S1/S2。

▲ 当你使用机型为 V100 O 时，此界面可开启或关闭光控引闪，其他机型光控引闪需在菜单开启或关闭。更多关于光控引闪内容可参考说明书机顶模式 M 档手动模式章节。

🔊) 蜂鸣器设置

开启蜂鸣器时，闪光会发出提示音。

触控使用：轻触屏幕的“蜂鸣器”图标可开启或关闭。

拨轮与按键使用：旋转调节拨轮选中“蜂鸣器”图标，短按设置按键可开启或关闭。

💡 造型灯设置

触控使用：轻触屏幕的“造型灯”图标可开启或关闭。造型灯开启时，可滑动下方的进度条进行 1-10 档位调节。

拨轮与按键使用：旋转调节拨轮选中“造型灯”图标，短按设置按键可开启或关闭。造型灯开启时，可旋转调节拨轮选中下方的进度条，短按设置按键进入亮度调节，旋转调节拨轮进行 1-10 档位调节，设置完毕短按设置按键退出。

🔒 屏幕锁定

触控使用：轻触屏幕“锁定”图标可开启锁定屏幕功能，长按屏幕 2s 解锁。

拨轮与按键使用：旋转调节拨轮选中“锁定”图标，短按设置按键可开启锁定屏幕功能，长按设置按键 2s 解锁。

⚡ 频闪闪光

以慢速快门使用频闪闪光时，可以在一张照片上拍摄出多个连贯的动作。您可以设置闪光频率（每秒闪光次数，以 Hz 表示）、闪光次数和闪光输出。

闪光功率范围：1/256-1/4 或 2.0~8.0

闪光次数：1-100

闪光频率：1-100

变焦调节范围：自动变焦或手动变焦

触控使用：轻触屏幕的“频闪”图标可开启或关闭。开启后，从屏幕下方往上滑动，频闪闪光设置界面出现。滑动闪光次数值选择次数，滑动赫兹选择闪光频率，轻触 - 图标或 + 图标调整闪光功率。变焦设置：轻触界面变焦图标进入设置界面，轻触选择自动变焦或所需焦距，设置完毕，轻触返回图标返回频闪界面。

拨轮与按键使用：旋转调节拨轮选中“频闪”图标，短按设置按键可开启或关闭。开启后，短按电源按键，频闪闪光设置界面出现。旋转调节拨轮可选闪光功率 / 闪光次数 / 闪光频率 / 变焦，选中某项后，短按设置按键进入闪光功率 / 闪光次数 / 闪光频率 / 变焦设置，旋转调节拨轮设置闪光功率 / 闪光次数 / 闪光频率 / 变焦，设置完毕短按设置按键退出。

使用频闪闪光，如何确定快门速度

频闪闪光停止之前，快门应保持开启状态。使用下面公式计算快门速度，然后用相机进行设置。

$$\text{闪光次数} \div \text{闪光频率} = \text{快门速度}$$

例如，如果闪光次数设为 10(次)且闪光频率设为 5(Hz)，需将快门速度设为 2 秒或更长。

▲ 为防止闪光灯过热导致损坏，请勿执行连续 10 次以上的频闪闪光。频闪闪光 10 次后，请让闪光灯至少冷却 15 分钟。如果您执行连续 10 次以上的频闪闪光连拍，为防止闪光灯头过热，闪光可能自动停止。如果发生了这种情况，请让闪光灯至少冷却 15 分钟。

- ❶
1. 反光很强的被摄体在暗背景前使用频闪闪光更加有效。
 2. 推荐使用三脚架和 TTL 引闪器 XPROII。
 3. 无法设置 1/1 和 1/2 闪光输出。
 4. 即使相机拍摄模式设置为 B 门拍摄 (buLb)，也可以进行频闪闪光。
 5. 频闪闪光模式无法设置高速同步。
 6. 不使用频闪闪光时，请关闭频闪闪光，否则设置不了 TTL 闪光或 M 手动闪光。

最大连续闪光次数

闪光次数 \ 闪光频率 (Hz)	1	2	3	4	5	6-7	8-9
1/4	8	6	4	3	3	2	2
1/8	14	14	12	10	8	6	5
1/16	30	30	30	20	20	20	10
1/32	60	60	60	50	50	40	30
1/64	90	90	90	80	80	70	60
1/128	100	100	100	100	100	90	80
1/256	100	100	100	100	100	90	80

闪光次数 \ 闪光频率 (Hz)	10	11	12-14	15-19	20-50	60-100
1/4	2	2	2	2	2	2
1/8	4	4	4	4	4	4
1/16	10	8	8	8	8	8
1/32	20	20	20	18	16	12
1/64	50	40	40	35	30	20
1/128	70	70	60	50	40	40
1/256	70	70	60	50	40	40

无线设置

触控使用：从屏幕左边往右滑动，屏幕出现模式界面。轻触屏幕上“无线设置”图标，进入无线设置界面。设置完毕，从屏幕左边往右滑动返回模式界面。

拨轮与按键使用：短按电源按键，屏幕出现模式界面。旋转调节拨轮选中“无线设置”图标，短按设置按键进入无线设置界面。设置完毕，短按电源按键返回模式界面。

频道	识别号
28	28
29	29
30	30

频道扫描 无线同步

扫描空闲频道

为了避免其他人使用同样频道受到干扰，可以使用频道扫描功能。

触控使用：轻触屏幕上“频道扫描”图标后开始扫描，不一会界面出现 8 组空闲频道，此时轻触您想要的频道，频道自动设置完毕。

拨轮与按键使用：旋转调节拨轮选中“频道扫描”图标，短按设置按键开始扫描，不一会界面出现 8 组空闲频道，此刻旋转调节拨轮选中您想要的频道，短按设置按键，频道自动设置。

频道设置

如果在拍摄现场不止一个无线闪光系统，您可以通过更改无线频道来防止信号干扰，但需保证主控单元和从属单元设置为相同频道。调节范围：范围为 01-32。

触控使用：滑动频道框，选择您所需的频道。

拨轮与按键使用：旋转调节拨轮选中频道范围，短按设置按键进入频道设置，旋转调节拨轮选中频道，设置完毕短按设置按键退出。

识别号设置

为了避免信号干扰，除了改变无线通讯频道还可以通过改变无线 ID 来防止干扰；主控单元和从控单元设为相同的频道和无线 ID 即可。调节范围为 OFF/01-99。

触控使用：滑动频道框，选择您所需的识别号或关闭识别号。

拨轮与按键使用：旋转调节拨轮选中识别号范围，短按设置按键进入识别号设置，旋转调节拨轮选中识别号，设置完毕短按设置按键退出。

无线同步

无线同步协助发射器与接收器，快速设置相同的频道与识别号。

无线同步接收器：

- 前提：1. 设置机器 V100 为主控模式，主界面上主控图标呈黄色。
2. 接收器假定为复古闪光灯 LUX MASTER。

触控使用：轻触 V100 上的无线同步，轻触复古闪光灯 LUX MASTER 上的无线同步即可无线同步。

拨轮与按键使用：旋转调节拨轮选中 V100 上的无线同步，短按设置按键进行无线同步，旋转调节拨盘选中复古闪光灯 LUX MASTER 上的无线同步，短按 SET 按键即可无线同步。

无线同步发射器：

- 前提：1. 设置机器 V100 为从属模式，主界面上从属图标呈黄色。
2. 发射器假定为引闪器 X3。

触控使用：轻触 V100 上的无线同步，轻触引闪器 X3 上的无线同步即可无线同步。

拨轮与按键使用：旋转调节拨轮选中 V100 上的无线同步，短按设置按键进行无线同步，旋转调节旋钮选中引闪器 X3 的无线同步，短按调节旋钮即可无线同步。

V100 无线同步：当主控单元和从属单元均为 V100 时，也能实现无线同步。

菜单设置

触控使用：从屏幕左边往右滑动，屏幕出现模式界面。轻触屏幕上“菜单”图标，进入菜单界面。设置完毕，从屏幕左边往右滑动返回模式界面。

拨轮与按键使用：短按电源按键，屏幕出现模式界面。旋转调节拨轮选中“菜单”图标，短按设置按键进入菜单界面。设置完毕，短按电源按键返回模式界面。

因不同机型的菜单顺序有所区别，具体菜单排序以实物显示为准，以下仅说明菜单功能。

图标	功能	选项	备注		
	主控闪光灯 (仅 V100 C 具备此功能)	关闭	主控单元闪光灯闪光关闭		
		开启	主控单元闪光灯闪光开启		
	功率显示	1/256 <table border="1" data-bbox="450 610 481 685"><tr><td>0.1</td></tr><tr><td>0.3</td></tr></table>	0.1	0.3	最小功率档位显示为 1/256、可选 0.1 档或 0.3 档为增量。
		0.1			
0.3					
2.0 <table border="1" data-bbox="450 685 481 760"><tr><td>0.1</td></tr><tr><td>0.3</td></tr></table>	0.1	0.3	最小功率档位显示为 2.0、可选 0.1 档或 0.3 档为增量。		
0.1					
0.3					
	光控引闪 (V100 O 可前往其他功能界面设置)	S1	支持在 M 手动闪光模式下使用，它会与主闪光灯的第一次闪光同步触发闪光		
		S2	支持在 M 手动闪光模式下使用，它会与主闪光灯的第二次闪光同步触发闪光		
	TCM	开启	可将 TTL 模式的闪光值转换为 M 模式功率值		
		关闭	此功能不生效		
	距离单位	m	米		
		ft	英尺		
	待机	开	开启后，超过规定时间（约 90 秒）无人操作，闪光灯会自动休眠		
		关	关闭后，超过规定时间（约 90 秒）无人操作，闪光灯不会自动休眠		
	自动关机	关	关闭自动关机功能		
		30 分钟	1. 待机关闭，处于机顶或主控模式，超过 30 分钟无人操作自动关机。 2. 处于从属模式，超过 30 分钟无人操作自动关机。		
		60 分钟	1. 待机关闭，处于机顶或主控模式，超过 60 分钟无人操作自动关机。 2. 处于从属模式，超过 60 分钟无人操作自动关机。		
		90 分钟	1. 待机关闭，处于机顶或主控模式，超过 90 分钟无人操作自动关机。 2. 处于从属模式，超过 90 分钟无人操作自动关机。		
	造型灯	持续	造型灯在闪光灯闪光时，持续点亮		
		闪灭	造型灯在闪光灯闪光时，自动灭		
	屏幕设置	无	屏幕亮度无极调节		
		30 秒钟	超过 30 秒无人操作屏幕待机		
		1 分钟	超过 1 分钟无人操作屏幕待机		
		2 分钟	超过 2 分钟无人操作屏幕待机		
		3 分钟	超过 3 分钟无人操作屏幕待机		
	变焦	4/3	4/3 系统（仅 V100 O 具备）		
		APS	APS 系统（仅 V100 F 具备）		
		135	135 系统（V100 C/V100 S/V100 N 默认此系统）		
	新协议 (仅 V100 S 具备此功能)	开启	此协议默认开启		
		关闭	相机与闪光灯出现不兼容情况时，关闭此项。		
	语言 /Language	中文	机器语言为中文		
		English	机器语言为英文		
	恢复出厂	否	取消恢复出厂设置操作		
		是	恢复出厂设置		
	设备信息	无	此界面显示机器型号及其固件版本号		

无线闪光拍摄 (2.4G 无线传输)

本章介绍使用发射器与接收器的无线电传输无线闪光摄影

本章将安装在相机上的 V100 称为“主控单元”，受无线控制的 V100 称为从属单元。

此外，您还可以另购 TTL 引闪器 XPROII 无线控制设为从属单元的 V100，具体关于引闪器的详细说明，请参考另购的引闪器说明书。

▲ 当相机的拍摄模式设为全自动模式或程序影像控制区模式时，无法利用本章中的操作。您需将相机的拍摄模式设为 Fv/P/Tv/Av/M/B 门 (创意拍摄区模式)。

使用具有无线电传输无线闪光摄影的闪光灯，利用无线多重闪光进行拍摄跟通常 TTL 自动闪光拍摄一样简单。

只要主控单元和从属单元设置的频道、组别、ID 保持一致，V100(主控单元)上的设置会自动应用到无线受控的 V100(从属单元)。因此在拍摄期间不需要操作接收单元。

定位和操作范围

●使用 1 个从属单元自动闪光

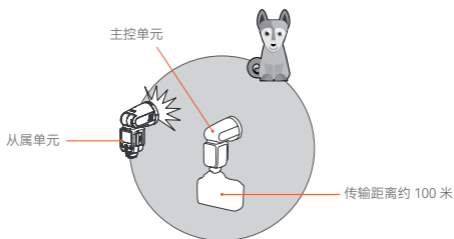

●使用多个从属单元自动闪光

您可以使用两个从属单元或三个从属单元进行 TTL 自动闪光拍摄并且可以改变闪光光比。

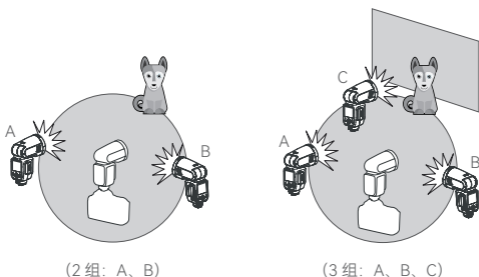

▲ 1. 开始拍摄前请进行测试闪光和试拍。
2. 受从属单元的位置、周围环境、天气状况等影响，传输距离可能更短。

- 为各组设定不同的闪光模式进行拍摄

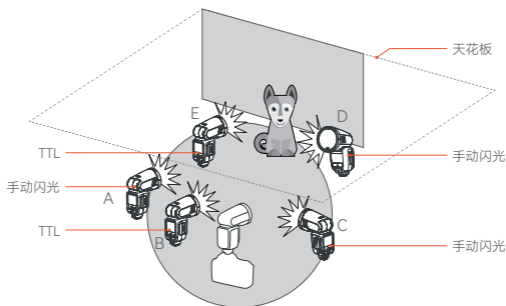

无线主控 / 从属设置

设置为主控单元

触控设置：从屏幕左边往右滑动，屏幕出现模式界面选项。轻触主控图标设置为主控单元，设置完毕，从屏幕左边往右滑动返回上一级。

拨轮与按键设置：短按电源按键，屏幕出现模式界面选项。旋转调节拨轮选中主控图标，短按设置按键设置为主控单元，设置完毕，短按电源按键返回上一级。

设置为从属单元

触控使用：从屏幕左边往右滑动，屏幕出现模式界面选项。轻触从属图标设置为从属单元，设置完毕，从屏幕左边往右滑动返回上一级。

拨轮与按键使用：短按电源按键，屏幕出现模式界面选项。旋转调节拨轮选中从属图标，短按设置按键设置为从属单元，设置完毕，短按电源按键返回上一级。

关于主控单元

您可以使用两个或两个以上主控单元，通过准备多台装有主控单元的相机，可以在保持相同照明（从属单元）期间更换相机进行拍摄。

主控单元（闪光灯）闪光开 / 关（仅 V100 C 具备此功能）

您可以设置主控单元闪光灯是否闪光，当主控单元闪光灯闪光设置开启时，主控单元闪光灯作为闪光 A 组进行闪光。

触控使用：从屏幕左边往右滑动，屏幕出现模式界面选项。轻触屏幕上“菜单”图标，进入菜单设置界面。滑动屏幕找到主控闪光图标，轻触主控闪光图标→轻触关闭或开启。

拨轮与按键使用：短按电源按键，屏幕出现模式界面选项。旋转调节拨轮选中“菜单”图标，短按设置按键进入菜单设置界面。旋转调节拨轮选中主控闪光，短按设置按键进入主控闪光设置，旋转调节拨轮选关闭或开启，短按设置按键完成设置。设置完毕，短按电源按键返回上一级。

6 主控单元闪光灯闪光关闭，并不影响传输无线闪光信号。

TTL: 全自动无线闪光拍摄

以下说明使用触控方式，实际上，您也可使用拨轮与按键。

●使用一个从属单元的自动闪光拍摄

1. 设置主控单元

轻触屏幕的主控模式，将安装在相机上的 V100 设为主控单元。

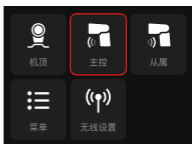

2. 设置从属单元

轻触屏幕的从属模式，将闪光灯 V100 设为从属单元。

您也可以使用引闪器 X2T 作为主控单元。X2T 可以控制 V100 的变焦值，但变焦值必须调至自动 (A) 模式。

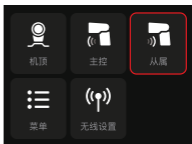

3. 检查传输频道 / 识别号

主控单元和从属单元的无线频道和识别号需设一致，举例，主控单元频道为 1，识别号为 1，从属单元也为 1 和 1。

您也可以使用无线同步功能，无需手动设置，极速同步频道和识别号。

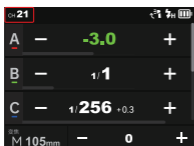

界面为 V100 C 主控界面，其他型号界面有所区别



4. 定位相机和闪光灯

主控单元与从属单元传输距离最大约 100 米。

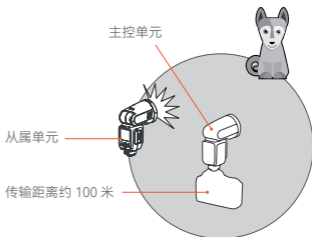

5. 将闪光模式设为 <TTL >

轻触主控单元闪光灯屏幕上的主控图标进入主控设置，长按组框切换至 TTL 自动闪光补偿值。

为了让主控单元闪光灯也闪光，您可进入菜单将主控闪光灯闪光设置为开启 (仅 V100 C 支持开启主控单元闪光)。

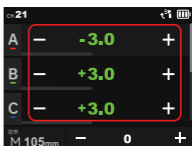

界面为 V100 C 主控界面，其他型号界面有所区别

6. 检查闪光灯是否准备就绪。

检查主控闪光灯就绪指示灯点亮。

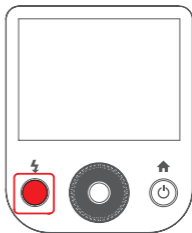

7. 检查操作

按下主控闪光灯的 <⚡> 试闪按钮，从属单元闪光。如果从属单元不闪光，检查是否将其放置在操作范围内。

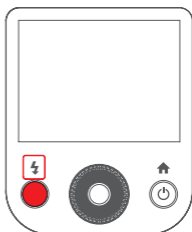

使用多个从属单元的自动闪光拍摄

当需要更大的闪光输出或想要更加轻松地进行照明时，可以增加从属单元的数量并将其作为单个闪光灯闪光。

要添加从属单元，使用与“使用一个从属单元的自动闪光拍摄”相同的步骤，可以设定任何闪光组 (A/B/C/D/E)。

当增加了从属单元的数量或主控闪光灯闪光设为开启时，执行自动控制以使所有闪光灯以相同的闪光输出闪光并确保总闪光输出能够达到标准曝光。

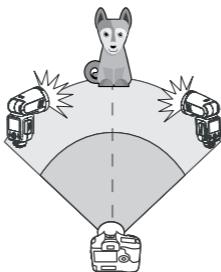

- ▲ 1. 短按相机上的景深预览按钮进行造型闪光 (V100 C)。
- 2. 如果从属单元的自动关闭电源生效，按下主控单元的试闪按键可以开启从属单元，请注意在相机的测光定时工作期间，无法进行测试闪光。
- 3. 您可以进入菜单，更改从属单元自动关闭电源时间，可以将自动关机时间改为 30 分钟或 90 分钟。

M 手动闪光的无线 (多重闪光) 拍摄

使用手动闪光的无线 (多重闪光) 拍摄, 可以在主控单元上设定所有参数, 为每个从属单元 (闪光组) 设定不同的闪光输出进行拍摄。

1. 轻触屏幕的主控图标, 将安装在相机的 V100 设为主控单元。

轻触主控单元闪光灯屏幕上的主控模式图标进入主控设置, 长按组框令组框出现 M 手动闪光的功率值。

2. 设置各组闪光组的闪光输出

轻触 - 图标或 + 图标设置各组闪光输出。

3. 设置频道和识别号

主控单元和从属单元的无线频道和识别号需设一致, 举例, 主控单元频道为 1, 识别号为 1, 从属单元也为 1 和 1。

您也可以使用无线同步功能, 无需手动设置, 极速同步频道和识别号。

4. 拍摄照片

各组从属单元以设定的闪光输出闪光。

频闪闪光的无线 (多重闪光) 拍摄

1. 将主控单元设为频闪闪光

轻触主控单元闪光灯屏幕上的主控图标进入主控设置。从屏幕上方往下拉动, 屏幕出现频闪图标, 轻触图标开启, 再从屏幕下方往上滑动, 令屏幕出现无线频闪闪光的相关参数。

2. 设置无线频闪的闪光输出、闪光次数、闪光频率

轻触 - 图标或 + 图标设置闪光输出。

滑动闪光次数选择所需闪光次数, 滑动闪光频率选择所需闪光频率。

3. 设置从属单元

轻触从属单元闪光灯屏幕上的从属图标进入从属设置。

4. 设置频道和识别号

举例, 主控单元频道为 1, 识别号为 1, 从属单元也为 1 和 1。

5. 设置从属闪光组无线频闪开 / 关

您可以直接在主控单元上设置从属单元 A/B/C/D/E 的无线频闪的开关。

▲ 在保证主控单元和从属单元频道、ID 设为一致的前提下, 从属单元无需调节其参数, 可直接在主控单元上调节参数。

其他应用

同步插孔触发

同步插孔规格为 $\Phi 2.5\text{mm}$ ，此处可插入同步线或者触发器触发插头对闪光灯进行同步引闪。

造型闪光 (V100 C 和 V100 N 具备此功能)

如果相机有景深预视按钮，按下该按钮将会进行 1 秒钟的连续闪光，这种现象称之为造型闪光。您可以通过造型闪光查看被摄体上的光影效果及照明平衡，不管是无线拍摄还是普通闪光拍摄，都可以进行造型闪光。

- 注：1. 请勿连续触发 10 次以上造型闪光。如果连续进行 10 次造型闪光，请让闪光灯至少冷却 10 分钟，以防止闪光灯头过热或损坏。
2. 佳能 EOS 300 和 B 型相机不支持造型闪光。
3. V100 S/V100 F/V100 O 闪光灯不支持造型闪光。

反射闪光

通过将闪光灯头指向墙壁或天花板，闪光在照亮被摄体前被墙面反射。这可以减轻被摄物体背后的阴影，获得更自然的摄影效果。称之为反射闪光。

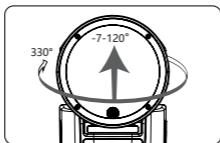

旋转闪光灯头来设置反射方向。

- 注：1. 如果墙壁或天花板太远，反射闪光可能太弱并导致曝光不足。
2. 墙壁或天花板应该是平坦的、白色的，有利于高效的反射。如果反射表面不是白色的，照片将出现偏色。

电池电量低警示

电池电量低时，电池符号 $\langle \square \rangle$ 变成红色，此时请更换电池或及时给电池充电。

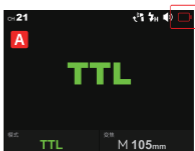

用相机菜单控制闪光灯（仅 V100 C 具备此功能）

将闪光灯安装在 EOS 相机上，可以从相机菜单为闪光灯设定自定义功能。可配置的主要功能如下。根据闪光模式、无线闪光功能设置和其他条件的不同，可用设置会有所不同

功能	
闪光灯闪光	启动 / 关闭
E-TTL 平衡	氛围优先 / 标准 / 闪光优先
TTL 测光	评价（面部优先） / 评价 / 平均
连拍闪光灯控制	每次拍摄 E-TTL / 首次拍摄 E-TTL
光圈优化模式下的闪光同步速度	
闪光模式	TTL 闪光测光（自动闪光） / 手动闪光 / 多次闪光（频闪）
无线闪光功能	无线闪光：关 / 无线电传输
闪光灯变焦（闪光覆盖范围）	
快门同步	前帘同步 / 后帘同步 / 高速同步
闪光曝光补偿	

闪光灯功能设置

1. 选择 < 闪光灯控制 > 或 < 外接闪光灯控制 >。



2. 选择 < 闪光灯功能设置 > 或 < 外接闪光灯功能设置 >。



3. 根据相机的不同，设置画面和显示的项目会有所不同。



1. 要清除闪光灯的所有自定义功能设置，您可选择步骤 2 画面中的 < 清除设置 >，然后清除所有闪光灯自定义功能或清除外接闪光灯的自定义功能设置。
2. 如果已经使用闪光灯设置了闪光曝光补偿，则无法用相机设置闪光曝光补偿，要用相机进行设置时，首先将闪光灯的闪光曝光补偿设置为“0”。
3. 如果用相机和闪光灯设置闪光曝光补偿以外的闪光灯自定义功能和闪光灯功能设置，最后所进行的设置将生效。

全域快门同步拍摄（仅 V100 S 具备此功能）

通过使用闪光灯 V100 S 和全域快门图像传感器的相机，闪光可以与相机上可用的整个快门速度范围同步，从而实现比传统高速同步拍摄 (HSS) 更有效的闪光曝光。

1. 闪光灯 V100 S 使用 TTL 自动闪光模式时，搭配全域快门相机，无论低速快门还是高速快门，闪光灯都能正常同步闪光。相对于非全域快门相机，使用全域快门相机，闪光灯高速同步闪光时间更短，约 2-5 毫秒，闪光灯回电更快，相机可拍摄更多张数。

2. 当您的闪光灯 V100 S 使用 M 手动闪光模式，但想在高速快门（快门速度快于 1/600）时采用单波闪光（非高速同步），您可以通过调整相机的闪光延迟时间来匹配相机的曝光时间，能够以更合适的光量进行拍摄。在此模式下，跟高速同步模式比，相同功率下得到更好的闪光指数。

相机闪光时间设置所在位置：相机的 MENU →  (曝光 / 颜色) → [闪光灯] → [闪光时间设置] → [开] → 将闪光时间设为所需值。

相机 ADJ 闪光时间设置菜单如下：

开：手动调整闪光时间（0 微秒到 1000 微秒）。

关：不调整闪光时间（当快门速度达到 1/600 选关，闪光的方式为非单波闪光）。

闪光和快门对齐调试方法：

高速快门单波闪光需要非常严格的时间对齐，原理如图，需要在闪光灯最佳光效里开启快门。

调试方法如下：

把闪光灯模式设到 M 档下，进入相机菜单，找到相机闪光时间设置，开启 ADJ。输入 ADJ 参数，ADJ 参数与您使用的相机及闪光灯有关，您如果使用的是 V100S 和 A9MIII，在 V100S 没有开启无线的情况下这个参数大约在 160 微秒，开启无线的情况下大约在 560 微秒（如使用其它全域快门相机时，需要全时间调试确定对齐时间）。调到以上参数后，把相机快门调到 1/80000，闪光灯功率调到 1/256（快门越快、功率越小时对齐要求越高，如果调好这个组合，其它的组合通常合适使用。当设置为快门速度快，功率高时，由于闪光的时间远大于快门时间，这时可以把时间向后移，选择闪光灯的发光峰值），如果发现闪光不同步时可以微调 ADJ 参数，调到曝光最佳时，这时可以测试其它快门下的拍摄情况。

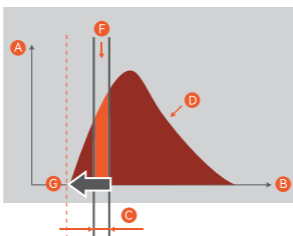

A: 闪光灯光量

D: 以 1/256 闪光时的闪光灯光量

B: 时间

F: 曝光的闪光灯光量

C: 快门速度

G: 闪光开始时间

- ▲ 1. 如果将相机的快门速度设为快于 1/10000 并拍摄照片，亮度和颜色可能会有所不同。
- 2. 对于配备全局快门图像传感器的相机，无论高速同步设置是否为 [ON]/[OFF]，相机上都不会显示 HSS 图标。
- 3. 当闪光灯使用同步线与相机连接，进行拍摄时，相机不再采用全域快门同步拍摄，而是采用传统的高速同步拍摄方式进行，因此闪光灯的光线可到达的距离缩短。

保护功能

热保护

- 为防止闪光灯头过热并损坏，请勿在 1/1 档位时进行超过 70 次的快速连续闪光。70 次连续闪光后，要让闪光灯至少冷却 10 分钟。
- 如您在进行超过 70 次连续闪光后马上继续进行更多次闪光，内部的防过热功能可能会被激活，使回电时间变为 10 秒以上。如果发生这种现象，请让闪光灯冷却约 10 分钟，闪光灯便会恢复正常。
- 热保护启动后，显示屏上的符号会显示。

激活过热保护功能的连续闪光次数：

闪光次数 \ 焦距	28mm	35mm	50mm	70mm	80mm	105mm
功率档位						
1/1	70	75	80	90	100	100
1/2	106	114	120	134	150	150
1/4	215	231	240	273	300	300
1/8	300	300	300	300	300	300
1/16	1200	1200	1200	1200	1200	1200
1/32	3500	3500	3500	3500	3500	3500
1/64						
1/128						
1/256						

高速同步模式下，激活热保护功能的连续闪光次数：

功率档位	连续闪光次数
1/1	60
1/2 (+0.1~+0.9)	70
1/4(+0.1~+0.9)	100
1/8(+0.1~+0.9)	
1/16(+0.1~+0.9)	
1/32(+0.1~+0.9)	
1/64(+0.1~+0.9)	
1/128(+0.1~+0.9)	
1/256(+0.1~+0.9)	

其他保护

为了保证设备安全的工作，系统时刻进行预防保护，以下提示符号供您参考：

LCD 显示	警示内容
Error1	闪光灯回电系统出现问题，无法回电引闪，请重新开机，如无法解决请维修
Error3	闪光灯管两端电压过高，请维修
Error5	闪光电路出现异常，请维修
Error9	固件升级有误，请进行正确固件升级

神牛 2.4G 无线漏闪原因及解决办法

1. 外部环境 2.4G 信号干扰 (如无线基站、2.4Gwifi 路由、蓝牙设备等)

→ 请调节引闪器的频道 CH 设置 (建议 +10), 找到无干扰的频道来工作, 或者在工作时关闭其他 2.4G 设备。

2. 请确认闪光灯是否已经回电或者回电速度已经跟上连拍速度 (闪光灯就绪指示灯已经亮起), 并且没有处于过热保护或者其他异常状态中

→ 请下调闪光灯的档位, 如是 TTL 模式可以尝试改为 M 模式 (TTL 模式下需要预闪一次)。

3. 是否引闪器和闪光灯距离太近 (距离 <0.5m)

→ 请在引闪器上打开“近距离无线模式”:

X1 系列: 按住引闪按钮不放, 然后开机, 直至指示灯闪 2 次。

Xpro、X2T 系列: 设置 C.Fn-DIST 为 0-30m。

X3 系列: 设置引闪距离为 0-30m。

4. 是否引闪器和接收端设备在低电状态

→ 请更换电池或及时充电。

5. 引闪器固件为旧版本

→ 请升级引闪器固件, 具体固件升级请参考引闪器说明书。

6. 相机固件为旧版本

→ 请升级相机固件, 具体固件升级请参考相机说明书。

规格参数

型号	V100 C	V100 S	V100 N
全域快门同步拍摄	不支持	支持	不支持
无线电无线全域快门同步	不支持	支持	不支持
造型闪光	支持	不支持	支持
闪光覆盖范围	自动变焦 (自动设置适合镜头焦距和图像尺寸的闪光覆盖范围)		
	手动变焦 (28-105 毫米)		

型号	V100 O	V100 F
全域快门同步拍摄	不支持	不支持
无线电无线全域快门同步	不支持	不支持
造型闪光	不支持	不支持
闪光覆盖范围	自动变焦 (自动设置适合镜头焦距和图像尺寸的闪光覆盖范围)	
	手动变焦 (28-105 毫米或 14-52mm)	手动变焦 (28-105 毫米或 18-69mm)





型号	V100 C/V100 S/V100 N/V100 O/V100 F
功率 (1/1 档位)	100Ws
灯头旋转范围	闪光灯头旋转 / 倾斜, 水平 0~330°, 垂直 -7°~120° (反射闪光)
闪光持续时间	1/300 秒— 1/20000 秒
曝光控制	
曝光控制系统	TTL 自动闪光、手动闪光
闪光曝光补偿 (FEC)	在 ±3 档间以 1/3 档为增量调节
同步方式	高速同步 (最高 1/8000 秒, Sony 全域快门相机最高可达 1/80000 秒)、前帘同步、后帘同步
频闪闪光	具备 (最大闪光次数 100 次; 最大闪光频率 100Hz)
无线闪光 (无线电 2.4G 传输)	
无线功能	主控单元 / 从属单元
主控单元组	A、B、C、D、E(V100 C) 或 M、A、B、C、D(V100 S/V100 N/V100 O/V100 F)
可控制从属单元组	A,B,C,D,E
传输范围 (约)	100m
频道	32 组: 01~32
ID	OFF/01~99
自动对焦辅助光 (V100 O 无此功能)	
有效范围 (约)	中央: 0.6-10 米 / 边缘: 0.6-5 米
LED 造型灯	
功率	2W
色温	3300K±200K
电源	
锂电池	7.2V/2980mAh 锂电池
回电时间	约 1.7 秒, 闪光灯准备就绪, 回电指示灯亮起
全功率闪光次数	约 400 次
节能	具备待机 / 自动关机功能
同步触发方式	热靴, 2.5mm 同步线
尺寸	
体积	71.5×76×206mm
净重 (不含电池)	约 496g
净重 (含电池)	约 616g

规格和参数如有变更, 恕不另行通知。

故障排除指南

如果遇到问题，请参阅此故障排除指南。

闪光灯不闪光

- 闪光灯没有牢固地安装在相机上。
→ 将闪光灯热靴座牢固地安装在相机上。
- 闪光灯和相机的电子触点变脏。
→ 请清洁触点。
- <  > 图标或 <  > 图标未出现在相机取景器中。
→ 请等待闪光灯回电完成，闪光灯准备就绪指示灯亮起。
→ 如果闪光灯准备就绪指示灯已经亮起，相机取景器中的 <  > 图标或 <  > 图标仍未亮起，请检查热靴连接，确保闪光灯可靠地装配在相机热靴上。
→ 若等待较长时间，闪光灯准备就绪指示灯一直没有亮起，请检查电池是否有电。如果电量低（闪光灯屏幕上电池图标变红），请更换电池或及时充电。

电源自动关闭

- 当灯处于机顶模式 / 主控模式时，待机开启，超过 90 秒无人操作时，闪光灯会进入休眠状态
→ 半按快门按键或机身任意键唤醒闪光灯
- 当灯处于机顶模式 / 主控模式时，待机关闭，自动关机开启，超过 60 分钟（或 30 分钟或 90 分钟）无人操作时，闪光灯会自动关机。
→ 重新开机
- 当灯处于从属模式时，自动关机开启，超过 60 分钟（或 30 分钟或 90 分钟）无人操作时，闪光灯会自动关机。
→ 重新开机

自动变焦不工作

- 闪光灯没有牢固地安装在相机上。
→ 将闪光灯的热靴座牢固地安装在相机上。

闪光曝光不足或过度

- 使用高速同步。
→ 使用高速同步，有效的闪光范围会更小，需要确保被摄体位于显示的有效闪光范围内。
- 闪光灯使用手动曝光模式。
→ 改为 TTL 模式或修改闪光输出功率设置。

相片出现暗角或者被摄物体只有局部能照亮

- 相机镜头焦距超出闪光灯的覆盖范围。
→ 请检查闪光灯当前的闪光覆盖范围，本产品的灯头变焦范围是全画幅系统 28-105mm。

固件升级

- 本产品 USB 接口为 USB Type-C 接口，请使用 USB Type-C 充电线。
- 产品升级固件需要 Godox G3 V1.1 程序软件支持，升级固件前请先下载安装“Godox G3 V1.1 固件升级软件”再选择相应的固件文件。
- 由于产品进行固件升级，说明书请以最新电子版为准。
- Godox G3 V1.1 固件升级软件下载地址：
<https://www.godox.com.cn/firmware-G3/>

兼容相机列表

V100 C 可兼容以下佳能 EOS 系列的相机型号：

80D、90D、7D、6D、70D、750D、760D、5D Mark IV、EOS 1DX、6D Mark II、77D、800D、5D Mark III、5D Mark II、60D、7D Mark II、600D、50D、30D、40D、500D、M5、M3、M50、R、RP、M6 II、R5、1500D、3000D、R7、R6 II、R50、R8、R5C、R10、R100、R5 II、R3、200D II

V100 S 可兼容以下索尼的相机型号：

a77 II、a99、a77、DSC-RX10、a6000、a7R、a6400、a7R II、a7R III、a7M3、a9、a7R IV、a7R5、a7M IV、ZV-E10、a58、ILCE6000L、a7R3、a350、a9 III

V100 N 可兼容以下尼康相机型号：

D800、D750、D700、D610、D500、D200、D300S、D5、D4、D810、D780、D5300、D5200、D5100、D5000、D3300、D3100、D60、Z6、Z7 II、Z8、ZFC

V100 O 可兼容以下奥林巴斯或松下相机型号：

奥林巴斯：E-M1、PEN-F、E-M10 II、E-PL8、E-P5、E-M10 III
松下：GH4、LX100、DMC-GF1、DMC-G85、DMC-GX85、DMC-LX100、DMC-FZ2500GK、S1

V100 F 可兼容以下富士相机型号：

根据富士对闪光灯的控制不同，分为以下类别进行区分：

A类：X-Pro2、X-T20、X-T2、X-T1、GFX50s、GFX50R、X-T30、X-T4、X-T3、X-S20、X-T5、X-H2、X-T50

B类：X-Pro1、X-T10、X-E1、X-A3

C类：X100F、X100T

相机兼容及功能支持对照表：

相机	机顶闪光灯						重复闪光
	TTL 闪光控制			M 闪光控制			
	前帘同步	后帘同步	高速同步	前帘同步	后帘同步	高速同步	
A类	√	√	√	√	√	√	√
B类	√	√	--	√	--	--	√
C类	√	√	√	√	√	√	√

相机	2.4G 主控从属闪光灯						重复闪光
	TTL 闪光控制			M 闪光控制			
	前帘同步	后帘同步	高速同步	前帘同步	后帘同步	高速同步	
A类	√	√	√	√	√	√	√
B类	√	√	--	√	√	--	√
C类	√	--	--	√	--	--	√

相机	AF 辅助对焦灯
A类	√
B类	--
C类	--

- ❗** 1. 相机 X100T 不支持后帘同步和高速拍摄功能，且不支持对焦辅助灯。
2. 相机 X-Pro1/X-T10 不支持高速拍摄功能，且不支持对焦辅助灯。当闪光灯设置为 M 模式时，无法更改相机的前帘和后帘模式。

- ▲** 1. 此表格仅列举目前已测试的相机型号，未涵盖所有相机型号。其他相机型号，用户可自行测试。
2. 本公司保留未来修改此表格内容的权利。

Contents

34	About This Instruction Manual
35	Important Safety Instructions
37	Foreword
38	Name of Parts Body Detachable Sub Flash SU-1 2.3 " LCD Panel
39	What's Inside
39	Separately Sold Accessories
40	Installing/Disassembling Battery
40	Battery Level Indication
41	Installing/Disassembling the Camera Flash
41	Installing/Disassembling SU-1
42	Power Management
43	Wi-Off Mode M: Manual Flash TTL: TTL Auto Flash ZOOM: Setting the Flash Coverage SUB: Detachable Sub Flash SU-1
45	Sender Mode Group M: Manual Flash—Flash Power TTL Auto Flash—Flash Exposure Compensation Amount Adjust the Parameters Uniformly ZOOM: Setting the Flash Coverage
46	Receiver Mode Group TTL: TTL Auto Flash M: Manual Flash Flash Power Settings ZOOM: Setting the Flash Coverage
47	Other Functions Sync Mode Auto Focus Assist Beam Photocell (V100 O) Beep Modeling Lamp Screen Lock Multi Flash
50	Wireless Settings Scan the Spare Channel Channel Settings ID Settings Wireless Sync
51	Menu
53	Wireless Flash Shooting (2.4G Wireless Transmission)
54	Wireless Sender/Receiver Settings
54	About the Sender Unit
54	Sender Unit's (Flash) ON/OFF(Only available in V100 C)
55	TTL: Fully Automatic Wireless Flash Shooting
57	M: Wireless Stroboscopic Flash Shooting with Manual Flash
57	 Wireless Stroboscopic Flash Shooting with Multi Flash
58	Other Applications Sync Triggering Modeling Flash(Only available in V100 C) Bounce Flash Low Battery Warning
59	Control with the Camera's Menu(Only available in V100 C)
59	Global Shutter Sync Photography(Only available in V100 S)
61	Protection Function

62	The Reason & Solution of Not Triggering in Godox 2.4G Wireless
63	Technical Data
64	Troubleshooting
64	Firmware Upgrade
65	Compatible Camera Models

About This Instruction Manual

This manual is based on the assumption that both the camera and camera flash's power switches are turned on.

The following alert symbols are used in this manual:

The caution symbol  indicates a warning to prevent shooting problem.

The note symbol  gives supplemental information.

Important Safety Instructions

This product is a professional photographic equipment, to be operated by professional personnel only.

All transport protective materials and packaging on the product must be removed before use.

The following basic safety precautions must be followed when using this product:

1. Carefully read and fully understand the instruction manual before use and strictly follow the safety instructions. Failure to do so may result in death, serious injury, damage to the product, or other property damage.
2. This product is a professional lighting fixture, children are prohibited from using it. Children must be closely supervised by adults when approaching the fixture, to prevent collisions with the fixture or unauthorized use that could cause personal injury.
3. This is not an ordinary lighting fixture and must not be used for general illumination. Anyone with a history of eye damage or sensitivity should avoid using this fixture or looking directly at it.
4. Extreme caution must be exercised when using it, do not touch high-temperature parts such as flash tubes to avoid burns.
5. Do not point the flash directly at the eyes (especially baby's eyes) under any circumstances, as this could impair vision in a short time. Turn off immediately if discomfort occurs, stop using, and seek medical attention promptly.
6. If the flash tube is damaged, stop using it immediately and contact the manufacturer, service agent, or qualified repair personnel for a replacement to prevent accidents.
7. Stop using immediately if the product shell is cracked due to falling, squeezing, or strong impact, to avoid touching the internal electronic components and getting an electric shock.
8. This device is not waterproof. Keep it dry and avoid immersing it in water or other liquids. It should be installed in a ventilated and dry location and avoid using in rainy, humid, dusty, or overheated environments. Do not place items above the device or allow liquids to flow into it to prevent danger.
9. Do not disassemble without authorization. If the product malfunctions, it must be inspected and repaired by our company or authorized repair personnel.
10. Before storing the device, make sure it is completely cooled.
11. Do not place the device near alcohol, gasoline, or other flammable volatile solvents or gases such as methane and ethane.
12. Do not use or store this device in potentially explosive environments.
13. Maintain at least 1 meter distance between the lamp head and the user, other people, and heat-sensitive or flammable items during and after use.
14. Do not use accessories not been approved by our company, as this may cause fire, electric shock or personal injury.
15. Clean gently with a dry cloth. Do not use a wet cloth as it may damage the device.
16. This instruction manual is based on rigorous testing. Changes in design and specifications are subject to change without notice. Check official website for latest instruction manual and product updates.
17. This product is powered by lithium batteries, who have limited lifespans and will gradually lose their charging capacities, which is irreversible. As the battery ages, the product's battery life will decrease. The lifespan of lithium battery is estimated to be 2 to 3 years. Please regularly check the battery, and if the charging time significantly increases or the battery life significantly decreases, consider replacing the battery.
18. This product is equipped with lithium batteries. The following are the storage recommendations: Charge the battery to about 50% before storage. Charge it to about 50% at least every six months. Removable batteries should be stored separately. The storage temperature should be between 0°C and 40°C.

19. Precautions for using lithium batteries:
- Do not disassemble, crush, or puncture the battery;
 - The battery is not waterproof, do not immerse it in fog or water;
 - Avoid short-circuiting the battery contacts;
 - Do not expose the battery to or put it into fire;
 - Do not expose the battery to temperatures above 60°C;
 - Keep out of reach of children;
 - Protect the battery from excessive shock or vibration;
 - Do not use a damaged battery;
 - If the battery leaks, avoid contact with the leaking fluid;
 - If the battery fluid comes into contact with your eyes, immediately rinse with water for at least 15 minutes. Lift your eyelids until there are no signs of fluid and seek medical attention promptly.
20. Confirm and comply with all relevant local laws and regulations when handling any batteries.
21. The warranty period for this device as a whole is one year. Consumables (such as batteries), adapters, power cords, and other accessories are not covered by the warranty.
22. Unauthorized repairs will void the warranty and will incur charges.
23. Please check the status and power of the lithium battery upon receipt. If there are any quality issues, please contact Godox or our authorized dealer within the warranty period.
24. Failures from improper operation is not covered under warranty.

Foreword

Thank you for purchasing!

TTL li-ion round head camera flash V100 is perfect for TTL auto flash with its excellent compatibility, you can enjoy unprecedented shooting convenience even with frequent changes in lighting conditions. Its main features include:

Quick Operations: 2.3" touch screen together with traditional buttons to achieve clear and easy operations.

High-speed Continuous Shooting (V100 S): Works seamlessly with global shutter cameras to break through flash sync speed limitations.

Round Flash Head: Well-crafted round flash head offers round, soft and even light effects.

Powerful Flash Functions: 100Ws flash power and 81 adjustable steps are suitable for full range of shooting needs.

LED Modeling Lamp: Built-in LED modeling lamp with adjustable brightness to preview light effects conveniently.

Effective Power Supply: 7.2V/2980mAh lithium battery provides 400 flashes and merely 1.7s recycle time at full power.

TTL Compatibility: Perfectly supports TTL auto flash to simplify the shooting procedure.

Wireless Control Ability: 2.4G wireless flash triggering extends more shooting possibilities.

Abundant Accessories Choices: Optional external power box PB960 improves shooting efficiency, while sub flash SU-1 brings better effects.

Professional Other Functions: Supports manual flash, Multi flash, high-speed sync, second-curtain sync, FEC, etc.

Stable Continuous Shooting: The output color and brightness remain consistent even in high-speed continuous shooting.

Firmware Upgrade: Firmware is updated regularly to be compatible with the latest camera models and ensure optimal performance.

Camera Compatibility: V100 C is compatible with Canon cameras, V100 S is compatible with Sony cameras, V100 N is compatible with Nikon cameras, V100 O is compatible with Olympus/Panasonic cameras, V100 F is compatible with Fujifilm cameras.

Note: The power box PB960 is sold separately.

Name of Parts

Body

1. Flash Head
2. LED Modeling Lamp
3. External Flash Interface
(for accessories such as sub flash SU-1)
4. Wireless Sensor
5. Focus Assist Beam
6. External Power Box Port
(for optional external power box PB960)
7. Bounce Angle Scale
8. Battery Charging Indicator
(red in charging, green in fully charged)
9. USB Type-C Charging Port
(for charging the battery)
10. Lithium Battery
11. Touch Screen
12. Power Switch Button
(Short press once to enter mode/return interface, press twice to enter other functions interface)
13. Hot Shoe
14. Hot Shoe Fixing Buckle
15. Test Button/Recycle Indicator
16. Select Dial
17. Set Button
(Short press to select or confirm)
18. Sync Cord Jack
19. USB-C Firmware Upgrade Port
(for upgrading the firmware)
20. Battery Remove Button

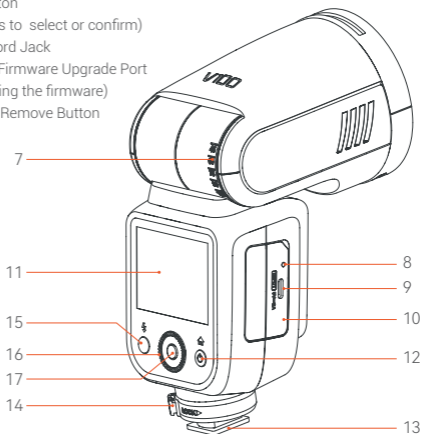
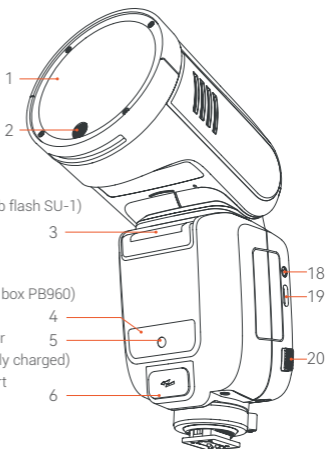

Detachable Sub Flash SU-1

1. Flash Tube
2. Detaching Pusher

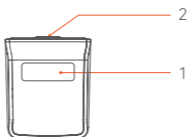

2.3 " LCD Panel

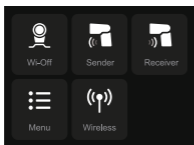

Mode Interface

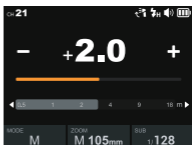

Wi-Off Mode

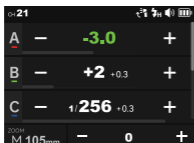

Sender Mode

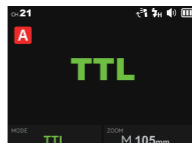

Receiver Mode

(This interface takes V100 C as an example, other models interfaces may differ)

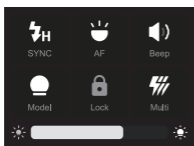

Other Functions

(V100 O doesn't have AF function)

What's Inside



Flash Body
x1

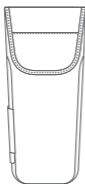

Storage
Bagx1



Adapter
x1



Mini Stand
x1



USB-C Charging
Cablex1



Lithium
Batteryx1



Detachable Sub
Flash SU-1 x1



Instruction
Manualx1

Separately Sold Accessories

The product can be used in combination with the following accessories sold separately, so as to achieve the best photography effects:

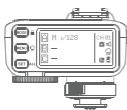

Flash Trigger X2T Series



Flash Trigger XProII Series



Flash Trigger X3 Series

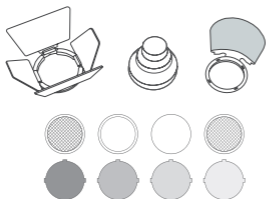

Accessory Kit for Round Flash Head AK-R1

Note: Please purchase the correct accessories according to your flash models.

Installing/Disassembling Battery

Disassembling the battery: Press and hold the battery remove button, then push the battery out of the battery compartment.

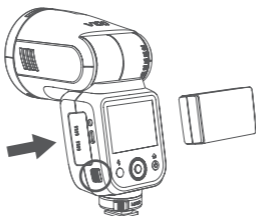

Installing the battery: Insert the battery into the battery compartment in the direction as referred below until it's firmly locked.

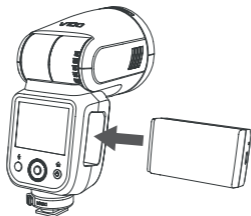

Battery Level Indication

Make sure the battery pack is securely loaded in the flash. Check the battery level indication on the LCD panel to see the remaining battery level.

Battery Level Indication	Meaning
3 grids	Full
2 grids	Middle
1 grid	Low
Blank grid	Lower battery, please recharge it.
No battery alert blinking	The battery level is going to be used out, and the flash is not functional in this status. Note: Please recharge the battery as soon as possible (within 10 days). Then, the battery can be used or be placed for long period.

Installing/Disassembling the Camera Flash

Installing the camera flash: Rotate the hot shoe fixing buckle to the left, insert the camera flash into the camera's hot shoe. Then rotate it to the right until it locks up.

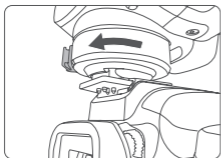

Disassembling the camera flash: Press and rotate the hot shoe fixing buckle to the left until it is loosened, then take off the camera flash.

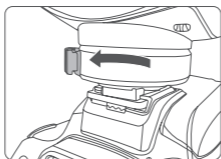

▲ Be sure to power off the camera and flash when installing and disassembling the flash to prevent damage to the devices.

Installing/Disassembling SU-1

Installing: Align the detachable sub flash SU-1 with the external flash interface of V100 and insert it parallelly, then press it down, a "click" sound means it's properly installed.

Disassembling: Push the detaching pusher on SU-1 and pull it up at the same time to detach it.

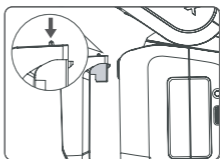
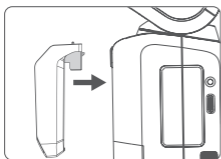

▲ Note: Please turn off V100 before installing and disassembling SU-1. Do not insert in or pull out SU-1 when V100 is in power on status or working, otherwise malfunctions may occur.

Power Management

Power On: Long press the power switch button until the < SET > icon appears on the panel, then slide the screen or rotate the select dial in the direction showed on the panel to turn it on.

Note: The screen backlight automatically turns off after 15 seconds of no operation in power-on status, and it can be lit up by touching.

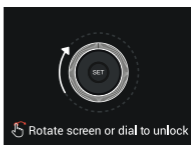

Standby: Setting as wi-off/sender mode when the standby function is on, the flash will enter standby mode automatically after a certain period (approx. 90 seconds) of idle use. Press the camera shutter halfway or press any button will wake up the flash unit.

Auto Off:

Setting as wi-off/sender mode when the auto off function is on, the flash will automatically shut down after 60 minutes (or 30 minutes, 90 minutes) of idle use.

Setting as receiver mode and the auto off function is on, the flash will automatically shut down after 60 minutes (or 30 minutes, 90 minutes) of idle use. The auto off function can be turned off manually when using off-camera as a receiver unit.

Wi-Off Mode

Touch Screen: Slide the screen from the left to the right to make the mode interface appears, click the "Wi-Off" icon to enter Wi-Off mode.

Buttons and Select Dial: Press the power switch button to make the mode interface appears, rotate the select dial and press the set button to choose and enter Wi-Off mode.

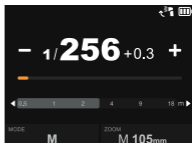
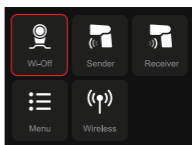

M: Manual Flash

The flash output is adjustable from 1/1 to 1/256 or from 2.0 to 10 with 0.1 or 0.3 increment each step. To obtain a correct flash exposure, use a hand-held flash meter to determine the required flash output.

Touch Screen: Click the "MODE" icon to switch to M mode, press the – or + icon to adjust the power with ± 0.1 or ± 0.3 increment each step, or directly pull the progress bar to achieve quick adjustment.

Buttons and Select Dial: Rotate the select dial and press the set button to choose "MODE" icon, then rotate and press again to choose "M". Rotate up to choose the power value, then rotate and press again to adjust power with ± 0.1 or ± 0.3 increment each step, quick adjustment is also available by fast rotation.

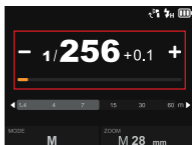

S1 Photocell Unit Setting

In M manual flash mode, this flash can function as an optic S1 secondary flash with optic sensor. With this function, the flash will fire synchronously when the main flash fires, the same effect as that by the use of wireless triggers. This helps create multiple lighting effects.

S2 Photocell Unit Setting

In M manual flash mode, this flash can also function as an optic S2 secondary flash with optic sensor. This is useful when cameras have pre-flash function. With this function, the flash will ignore a single "pre-flash" from the main flash and will only fire in response to the second, actual flash from the main flash.

- ▲ 1. S1 and S2 Photocell triggering is only available in M manual flash mode.
- 2. Enter menu setting to switch between S1/S2 Photocell or turn off this function.
- 3. The Photocell function can be turned on or off in other function interface for V100 O.

TTL: TTL Auto Flash

In TTL mode, the camera's metering system detects the flash reflected from the subject and automatically adjusts the flash output so that the subject and background are evenly exposed.

Touch Screen: Click the "MODE" icon to switch to TTL mode, press the – or + icon to adjust the FEC amount among ± 3 with $\pm 1/3$ increment each step, or directly pull the progress bar to achieve quick adjustment.

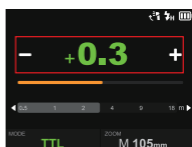

Buttons and Select Dial: Rotate the select dial and press the set button to choose "MODE" icon, then rotate and press again to choose "TTL". Rotate up to choose the FEC amount, then rotate and press again to adjust the FEC amount among ± 3 with $\pm 1/3$ increment each step, quick adjustment is also available by fast rotation.

- Press the camera shutter halfway to focus. The effective flash range will be displayed in the LCD panel.
- When the shutter is fully pressed, the flash will fire a pre-flash that the camera will use to calculate exposure and flash output the instant before the photo is taken.

ZOOM: Setting the Flash Coverage

The flash coverage can be set automatically or manually. In auto zoom mode, the focal length changes in response to the camera's zoom lens to provide optimal flash results.

Auto Zoom Mode: A--mm, and the flash coverage will be set automatically.

Manual Zoom Mode: 28mm-105mm (V100 C/V100 S/V100 N), 28mm-105mm or 14-52mm (V100 O), 28mm-105mm or 18-69mm (V100 F)

Touch Screen: Click the "ZOOM" icon to switch between auto zoom(A--mm) mode or manual zoom mode.

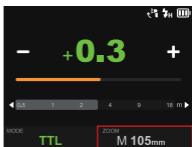

Buttons and Select Dial: Rotate the select dial and press the set button to choose "ZOOM" icon, then rotate and press again to choose the needed zoom mode.

- ▲ If you set the flash coverage manually, make sure it covers the lens focal length so that the picture will not have a dark periphery.

SUB: Detachable Sub Flash SU-1

With detachable sub flash SU-1 attached to the external flash interface, better filling light effects can be achieved in M (manual) flash/TTL auto flash mode, this is helpful for portrait shooting.

Installation: Mount SU-1 directly to the external flash interface of V100, a "click" sound means it's properly installed.

Flash Power Range: From 1/128 to 1/1 or from 3.0 to 10 in 8 steps, with $+1/3$ increment each step.

Touch Screen: Click the "SUB" icon to adjust its flash power by pressing "-" or "+" icon or sliding the progress bar. Turn on or off the sub flash by clicking the on/off icon down the screen.

Buttons and Select Dial: Rotate the select dial and press the set button to choose "SUB" icon, then rotate and press it again to adjust its flash power or turn it on/off.

- ▲ 1. Be sure to power off the flash before installing and disassembling the sub flash.
- 2. SU-1 is not useable in sender or receiver mode.
- 3. The flash head need to be uplifted in order to use SU-1 properly.
- 4. External flash do not support HSS.

Sender Mode

Touch Screen: Slide the screen from the left to the right to make the mode interface appears, click the "Sender" icon to enter sender mode, slide upward can check more groups.

Buttons and Select Dial: Press the power switch button to make the mode interface appears, rotate the select dial and press the set button to choose and enter sender mode, rotate the select dial can check more groups.

The wireless is turned on by default in sender mode.

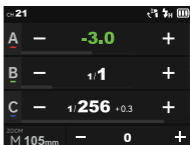
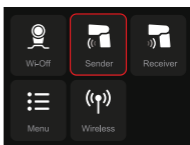

Group

Five groups: A, B, C, D, E(V100 C)

M, A, B, C, D(V100 S, V100 N, V100 O, V100 F)

M: Manual Flash—Flash Power

Touch Screen: Press and hold the group box to switch among M (manual) flash, TTL auto flash and OFF. If the value inside is from 1/256 to 1/1 or from 2.0 to 10, this group is in M (manual) flash mode and the value inside is the flash power. The flash power is adjustable by clicking the – or + icon, or quickly adjustable by pulling the progress bar.

Buttons and Select Dial: Rotate the select dial and press the set button to choose and enter a certain group, press and hold the set button to switch among M (manual) flash, TTL auto flash and OFF. If the value inside is between 1/256 to 1/1 or from 2.0 to 10, this group is in M (manual) flash mode and the value inside is the flash power. The flash power is adjustable by rotating the select dial, then press the set button to exit.

TTL Auto Flash—Flash Exposure Compensation Amount

Touch Screen: Press and hold the group box to switch among M (manual) flash, TTL auto flash and OFF. If the value inside is from -3.0 to +3.0, this group is in TTL auto flash mode and the value inside is the flash compensation amount. The flash compensation amount is adjustable by clicking the – or + icon, or quickly adjustable by pulling the progress bar.

Buttons and Select Dial: Rotate the select dial and press the set button to choose and enter a certain group, press and hold the set button to switch among M (manual) flash, TTL auto flash and OFF. If the value inside is between -3.0 to +3.0, this group is in TTL auto flash mode and the value inside is the flash compensation amount. The flash compensation amount is adjustable by rotating the select dial, then press the set button to exit.

Adjust the Parameters Uniformly

Touch Screen: Click the – or + icon can increase or decrease the flash power or FEC amount uniformly.

Buttons and Select Dial: Rotate the select dial and press the set button to choose and enter a certain group, press the set button to enter uniform adjustment and rotate the select dial to increase or decrease the flash power or FEC amount uniformly, then press the set button to exit.

ZOOM: Setting the Flash Coverage

You can choose auto zoom mode or manual zoom mode (28mm-105mm). The details of which please refer to the ZOOM section in the Wi-Off mode above.

Receiver Mode

Touch Screen: Slide the screen from the left to the right to make the mode interface appears, click the “Receiver” icon to enter receiver mode.

Buttons and Select Dial: Press the power switch button to make the mode interface appears, rotate the select dial and press the set button to choose and enter receiver mode.

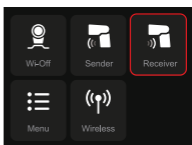

The wireless is turned on by default in receiver mode.

Group

Five receiver groups: A, B, C, D, E

Touch Screen: Click the group icon to switch groups.

Buttons and Select Dial: Rotate the select dial to choose the group icon, then press the set button to enter group settings and rotate the select dial to switch groups, finally press the set button again to exit.

TTL: TTL Auto Flash

Touch Screen: Click the “MODE” icon to switch to TTL mode.

Buttons and Select Dial: Rotate the select dial to choose the “MODE” icon, then press the set button to enter MODE settings and rotate the select dial to switch to TTL mode, finally press the set button again to exit.

 The details of which please refer to the section Wi-Off mode → TTL auto flash above.

M: Manual Flash

Touch Screen: Click the “MODE” icon to switch to M mode.

Buttons and Select Dial: Rotate the select dial to choose the “MODE” icon, then press the set button to enter MODE settings and rotate the select dial to switch to M mode, finally press the set button again to exit.

 The details of which please refer to the section Wi-Off mode → M: manual flash above.

Flash Power Settings

The flash power adjustable from 1/256 to 1/1 or from 2.0 to 10 when choosing M (flash) mode.

Touch Screen: The flash power is adjustable by clicking the – or + icon, or quickly adjustable by pulling the progress bar.

Buttons and Select Dial: Rotate the select dial to choose the flash power box, press the set button to enter flash power settings and rotate the select dial to adjust, finally press the set button again to exit.

ZOOM: Setting the Flash Coverage

You can choose auto zoom mode or manual zoom mode (28mm-105mm). The details of which please refer to the ZOOM section in the Wi-Off mode above.

Other Functions

Touch Screen: When in Wi-Off/Sender/Receiver mode, slide the screen down to make other functions appear, slide up to return to the main interface.

Buttons and Select Dial: When in Wi-Off/Sender/Receiver mode, short press the power switch button twice to make other functions appear, press it again to return to the main interface.

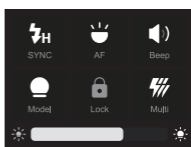

V100 C/S/N/F

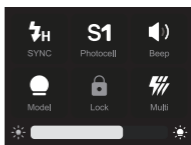

V100 O

Sync Mode

⚡ High-speed Sync

High speed sync (FP flash) enables the flash to synchronize with all camera shutter speeds. This is convenient when you want to use aperture priority for fill-flash portraits.

▶▶ Second-curtain Sync

With a slow shutter speed and second-curtain sync, you can create a light train following the subject. The flash fires right before the shutter closes.

Touch Screen: Click the "SYNC" icon to switch sync mode(V100 C). Click the "SYNC" icon can only turn on or off HSS, second-curtain sync need to be set on cameras (V100 S/V100 O/V100 F, or V100 N but not connected to Nikon cameras).

Buttons and Select Dial: Rotate the select dial to choose "SYNC" icon, then press the set button to switch sync mode(V100 C). Press the set button can only turn on or off HSS, second-curtain sync need to be set on cameras (V100 S/V100 O/V100 F, or V100 N but not connected to Nikon cameras).

Note:When using V100 N and connected to Nikon cameras,the HSS will be automatically turned on if the Nikon camera is set to fast shutter speed, while be automatically turned off if the Nikon camera is set to low shutter speed.

☹ Auto Focus Assist Beam(unavailable in V100 O)

In poorly-lit or low-contrast shooting environments, the built-in auto focus assist beam will automatically light on to make it easier for autofocus. The beam will light up only when autofocus is difficult and get out as soon as the autofocus becomes correct.

Touch Screen: Click the "AF" icon to turn on or off the auto focus assist beam.

Buttons and Select Dial: Rotate the select dial to choose "AF" icon, then press the set button to turn on or off the auto focus assist beam.

Position	Effective Range
Center	0.6~10m / 2.0~32.8 feet
Periphery	0.6~5m / 2.0~16.4 feet

📌 If you find the auto focus assist beam does not light up, this is because the camera has got a correct autofocus.

Photocell (V100 O)

Touch Screen: Click the "Photocell" icon to switch among OFF, S1 or S2.

Buttons and Select Dial: Rotate the select dial to choose "Photocell" icon, then press the set button to switch among OFF, S1 or S2.

▲ The photocell function can be turned on or off in this interface for V100 O, while other models need to be turned on or off in the menu. The details of which please refer to the M: manual flash section in the Wi-Off mode above.

Beep

The flash will fire with a prompt tone if the beep is turned on.

Touch Screen: Click the "Beep" icon to turn on or off the beep.

Buttons and Select Dial: Rotate the select dial to choose "Beep" icon, then press the set button to turn on or off the beep.

Modeling Lamp

Touch Screen: Click the "Model" icon to turn on or off the modeling lamp. The brightness of it is adjustable from 1 to 10 by pulling the progress bar down when it's turned on.

Buttons and Select Dial: Rotate the select dial to choose "Model" icon, then press the set button turn on or off the modeling lamp. When the modeling lamp is on, its brightness is adjustable from 1 to 10 by rotating the select dial and pressing the set button after selecting the progress bar down, then press the set button again to exit.

Screen Lock

Touch Screen: Click the "Lock" icon to turn on the screen lock, press and hold for 2s to unlock.

Buttons and Select Dial: Rotate the select dial to choose "Lock" icon, then press the set button to turn on the screen lock, press and hold for 2s to unlock.

Multi Flash

With slow shutter speed in multi flash mode, a rapid series of flashes is fired. It can be used to capture multiple images of a moving subject in a single photograph.

You can set the flash frequency (number of flashes per sec. expressed as Hz), the number of flashes, and the flash output.

Flash output range: 1/256-1/4 or 2.0-8.0.

Number of flashes: 1-100

Flash frequency: 1-100

ZOOM range: auto zoom or manual zoom.

Touch Screen: Click the "Multi" icon to turn on or off the multi flash. When the multi flash is turned on, slide the screen up can adjust the parameters. Slide the number in front of "Times" can adjust the number of flashes, slide number in front of "Hz" can adjust the flash frequency, click the - or + icon can adjust the flash power, press the "ZOOM" icon down to enter the ZOOM setting interface and choose auto zoom or manual zoom, then adjust the ZOOM value. Finally press the return icon to back to the multi flash interface.

Buttons and Select Dial: Rotate the select dial to choose "Multi" icon, then press the set button to turn on or off the multi flash. When the multi flash is turned on, press the power switch button to make the parameters interface appears, then the flash power, number of flashes, flash frequency and ZOOM value are all adjustable by rotating the select dial, finally press the set button again to exit.

Calculating the Shutter Speed

During multi flash, the shutter remains open until the firing stops. Use the formula below to calculate the shutter speed and set it with the camera.

$$\text{Number of Flashes} \div \text{Flash Frequency} = \text{Shutter Speed}$$

For example, if the number of flashes is 10 and the flash frequency is 5Hz, the shutter speed should be at least 2 seconds.

▲ To avoid overheating and deteriorating the flash head, do not use multi flash more than 10 times in succession. After 10 times, allow the camera flash to rest for at least 15 minutes. If you try to use the multi flash more than 10 times in succession, the firing might stop automatically to protect the flash head. If this happens, allow at least 15 minutes' rest for the camera flash.

- 📌**
1. Multi flash is most effective with a highly reflective subject against a dark background.
 2. Using a tripod and TTL flash trigger XPROII is recommended.
 3. A flash output of 1/1 and 1/2 cannot be set for multi flash.
 4. Multi flash can also be used with "buLb" mode.
 5. Multi flash mode cannot be set in high-speed sync mode.
 6. Please turn off the multi flash when not using, otherwise TTL flash and M flash are not available.

Maximum Time of Consecutive Flashes

Number of Flashes Flash Output	Flash Frequency(Hz)	1	2	3	4	5	6-7	8-9
		1/4	8	6	4	3	3	2
1/8	14	14	12	10	8	6	5	
1/16	30	30	30	20	20	20	10	
1/32	60	60	60	50	50	40	30	
1/64	90	90	90	80	80	70	60	
1/128	100	100	100	100	100	90	80	
1/256	100	100	100	100	100	90	80	

Number of Flashes Flash Output	Flash Frequency(Hz)	10	11	12-14	15-19	20-50	60-100
		1/4	2	2	2	2	2
1/8	4	4	4	4	4	4	
1/16	10	8	8	8	8	8	
1/32	20	20	20	18	16	12	
1/64	50	40	40	35	30	20	
1/128	70	70	60	50	40	40	
1/256	70	70	60	50	40	40	

Wireless Settings

Touch Screen: Slide the screen from the left to the right to make the mode interface appears, click the "Wireless" icon to enter wireless mode. Then slide from the left to the right to return to the main interface.

Channel	ID
28	28
29	29
30	30
SCAN	SYNC

Buttons and Select Dial: Press the power switch button to make the mode interface appears, rotate the select dial and press the set button to choose and enter wireless mode. Short press the power switch button to return to the main interface.

Scan the Spare Channel

You can scan the spare channel to avoid the interference of using the same channel by others.

Touch Screen: Click the "SCAN" icon to start scanning, and the 8 spare channels will be displayed, click your desired channel.

Buttons and Select Dial: Rotate the select dial to choose "SCAN" icon, then press the set button to start scanning, and the 8 spare channels will be displayed, rotate the select dial and press the set button to choose your desired channel.

Channel Settings

If there are other wireless flash systems nearby, you can change the wireless channels to prevent signal interference. The wireless channels (01-32) of the sender unit and the receiver unit(s) must be set to the same.

Touch Screen: Slide the "Channel" box to choose your desired channel.

Buttons and Select Dial: Rotate the select dial to choose "Channel" box, then press the set button to enter channel settings, rotate the select dial and press the set button to choose your desired channel, finally press the set button to exit.

ID Settings

Change the wireless ID to avoid interference for it can only be triggered after the wireless IDs (OFF/01-99) of the sender unit and the receiver unit are set to the same.

Touch Screen: Slide the "ID" box to turn off the ID, or choose your desired ID.

Buttons and Select Dial: Rotate the select dial to choose "ID" box, then press the set button to enter ID settings, rotate the select dial and press the set button to choose your desired ID, finally press the set button to exit.

Wireless Sync

The wireless sync function helps the sender and receiver to quickly set the same channel and ID.

Receiver Wireless Sync

Preconditions:

1. Set V100 to sender mode and the "Sender" icon on the panel is yellow.
2. Assume retro camera flash Lux Master as the receiver.

Touch Screen: Click the "SYNC" icon on both V100 and Lux Master.

Buttons and Select Dial: Rotate the select dial on V100 to choose "SYNC" icon, then press the set button. Rotate the select dial on Lux Master to choose "SYNC" icon, then press the SET button.

Sender Wireless Sync

Preconditions:

1. Set V100 to receiver mode and the "Receiver" icon on the panel is yellow.
2. Assume flash trigger X3 as the sender.

Touch Screen: Click the "SYNC" icon on both V100 and X3.

Buttons and Select Dial: Rotate the select dial on V100 to choose "SYNC" icon, then press the set button. Rotate the select dial on X3 to choose "SYNC" icon, then press the select dial.





When the sender unit and receiver unit are both V100, wireless sync is also available.









Menu

Touch Screen: Slide the screen from the left to the right to make the mode interface appears, click the "Menu" icon to enter the menu interface. Then slide from the left to the right to return to the main interface.

Buttons and Select Dial: Press the power switch button to make the mode interface appears, rotate the select dial and press the set button to choose and enter the menu interface. Short press the power switch button to return to the main interface.

Due to the difference in the menu order of different models, the specific menu ordering is subject to the actual product models, the following only explains the menu functions.

Icon	Function	Options	Description	
	Sender Flash (only available in V100 C)	Off	Sender flash off	
		On	Sender flash on	
	Power Type	1/256	0.1	Minimum power step is 1/256, 0.1 or 0.3 increment are available for choice
			0.3	
		2.0	0.1	Minimum power step is 2.0, 0.1 or 0.3 increment are available for choice
			0.3	
	Photocell (Available in other interface for V100 O)	S1	Only available in M (manual) flash mode, the flash will fire synchronously when the main flash fires.	
		S2	Only available in M (manual) flash mode, the flash will ignore a single "pre-flash" from the main flash and will only fire in response to the second, actual flash from the main flash.	
	TCM	On	Flash value of TTL mode can be converted to the power value of M mode	
		Off	Turn off this function	
	m/ft	m	Meter	
		ft	Feet	
	Standby	On	Automatically standby after the set time (90 seconds) of idle use.	
		Off	Do not automatically standby after the set time (90 seconds) of idle use.	

Icon	Function	Options	Description
	Auto Off	Off	Turn off auto power off function
		30 min	1. Setting as wi-off/sender mode when the standby function is off, the flash will automatically shut down after 30 minutes of idle use. 2. Setting as receiver mode, the flash will automatically shut down after 30 minutes of idle use.
		60 min	1. Setting as wi-off/sender mode when the standby function is off, the flash will automatically shut down after 60 minutes of idle use. 2. Setting as receiver mode, the flash will automatically shut down after 60 minutes of idle use.
		90 min	1. Setting as wi-off/sender mode when the standby function is off, the flash will automatically shut down after 90 minutes of idle use. 2. Setting as receiver mode, the flash will automatically shut down after 90 minutes of idle use.
	Model	Continue	The modeling lamp is constant on when flashing.
		Interrupt	The modeling lamp automatically turns off when flashing.
	Screen	/	Screen brightness is steplessly adjustable.
		30 sec	Screen standby after 30 seconds of idle use.
		1 min	Screen standby after 1 minute of idle use.
		2 min	Screen standby after 2 minutes of idle use.
		3 min	Screen standby after 3 minutes of idle use.
	Zoom	4/3	4/3 system (only available in V100 O)
		APS	APS system (only available in V100 F)
		135	135 system (default in V100 C/V100 S/V100 N)
	New Agreement (only available in V100 S)	On	The new agreement is turned on by default.
		Off	Turn off the new agreement in case of incompatibility of flash and camera.
	Language	Simplified Chinese	Simplified Chinese system
		English	English system
	Factory Reset	Cancel	Cancel factory reset
		Apply	Factory reset
	Device Info	/	Display the device model and firmware version

Wireless Flash Shooting (2.4G Wireless Transmission)

This section explains wireless sending/receiving flash shooting.

The V100 attached to the camera is referred as the sender unit, while a V100 that is wirelessly controlled is referred as the receiver unit.

You can also wirelessly control the V100 set as the receiver unit with the TTL flash trigger XPROII (sold separately). For details on setting the flash trigger functions, see the its instruction manual.

▲ When the camera's shooting mode is set to a fully automatic mode or an image zone mode, the operations in this section are not available. Please set the camera's shooting mode to Fv/P/Tv/Av/M/B.

Using a flash with a radio transmission wireless shooting function make it easy to shoot with advanced wireless multiple flash shooting, in the same way as TTL auto flash shooting.

As long as the channel, group, ID, and other relevant wireless settings of the sender and receiver units are set to the same, the settings on the V100 (sender unit) will be automatically applied to the wirelessly controlled V100 (receiver unit). Therefore, there is no need to operate the receiver unit during shooting.

Positioning and Operation Range

● Auto Flash Shooting with One Receiver Unit

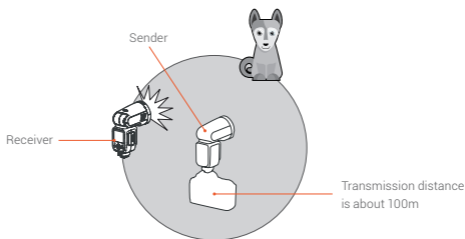

● Auto Flash Shooting with Multiple Receiver Groups

You can divide the receiver units into two or three groups and perform TTL auto flash while changing the flash ratio (flash output ratio).

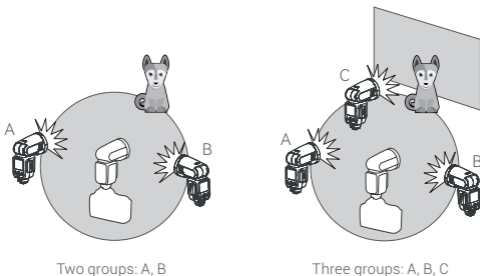

- ▲ 1. Before shooting, perform a test flash and test shooting.
2. The transmission distance might be shorter depending on the conditions such as positioning of receiver units, the surrounding environment and whether conditions.

● Shooting with a Different Flash Mode Set for Each Group

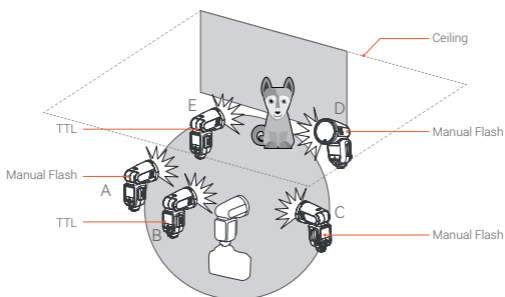

Wireless Sender/Receiver Settings

Set as a Sender Unit

Touch Screen: Slide the screen from the left to the right to make the mode interface appear, click the "Sender" icon to enter sender mode, slide from the left to the right to return to the main interface.

Buttons and Select Dial: Press the power switch button to make the mode interface appear, rotate the select dial and press the set button to choose and enter sender mode. Short press the power switch button to return to the main interface.

Set as a Receiver Unit

Touch Screen: Slide the screen from the left to the right to make the mode interface appear, click the "Receiver" icon to enter receiver mode, slide from the left to the right to return to the main interface.

Buttons and Select Dial: Press the power switch button to make the mode interface appear, rotate the select dial and press the set button to choose and enter receiver mode. Short press the power switch button to return to the main interface.

About the Sender Unit

Use two or more sender units. By preparing several cameras that with sender units attached, cameras can be changed in shooting while keeping the same lighting source (receiver unit).

Sender Unit's (Flash) ON/OFF(Only available in V100 C)

You can set whether the sender unit flash that sends wireless signal flashes or not, and when the sender unit flash setting is on, the flash fires as a flash A group.

Touch Screen: Slide the screen from the left to the right to make the mode interface appear, click the "Menu" icon to enter menu interface, choose "Sender Flash" icon and click to turn on or off the sender flash.

Buttons and Select Dial: Press the power switch button to make the mode interface appear, rotate the select dial and press the set button to enter menu interface and choose "Sender Flash", then rotate the select dial and press the set button to turn on or off the sender flash. Short press the power switch button to return to the main interface.

6 Even if the sender unit flash firing is off, it still sends wireless flash signals.

TTL: Fully Automatic Wireless Flash Shooting

The below instructions are described in touch screen operation, you can also use buttons and select dial.

● Using Automatic Wireless Flash with a Single Receiver Unit

1. Sender Unit Setting

Click the "Sender" icon on the panel, then the V100 attached to the camera is set as the sender unit.

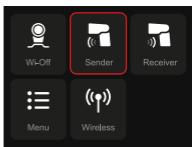

2. Receiver Unit Setting

Click the "Receiver" icon on the panel, then the V100 wirelessly controlled is set as the receiver unit.

X2T can also be set as sender unit. X2T can control V100's ZOOM value when the ZOOM is adjusted to auto (A) mode.

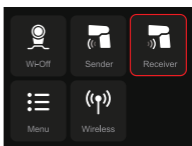

3. Check the Communication Channel /ID

Set the wireless channels and IDs of sender unit and receiver unit to the same. For example, if the sender unit channel is set to 1, then the receiver unit channel needs to be 1 as well.

You can also use the wireless sync function to set the channels and ID to the same quickly.

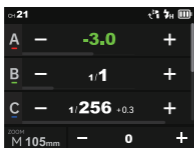

(This interface takes V100 C as an example, other models interfaces may differ)

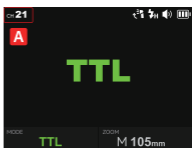

4. Position the Camera and Flashes

The transmission distance of the sender unit and receiver unit is about 100m.

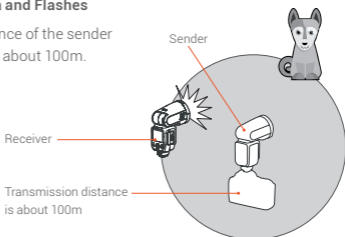

5. Set the Flash Mode to <TTL>

Click the "Sender" icon on the panel to enter sender mode. Press and hold the group box to switch to TTL auto flash compensation amount.

Please set the sender unit's flash to ON in order to make the sender unit fire flashes(only available in V100 C).

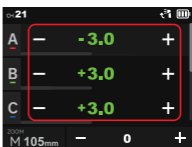

(This interface takes V100 C as an example, other models interfaces may differ)

6. Check Whether the Flash is Ready

Check whether the sender unit's flash ready indicator is lightened.

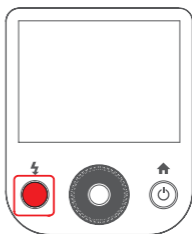

7. Check the Flash Operation

Press the sender unit's test button < ⚡ >. Then, the receiver unit will fire. If not, adjust the distance from the sender unit.

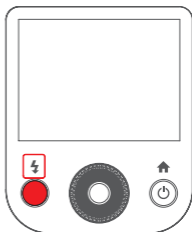

● Using Automatic Wireless Flash with Multiple Receiver Units

When stronger flash output or more convenient lighting operation is needed, increase the number of receiver units and set it as a single receiver unit.

To add receiver units, use the same steps as setting "using automatic wireless flash with a single receiver unit". Any flash group can be set (A/B/C/D/E).

When the number of receiver units is increased or the sender unit flash firing is ON, automatic control is implemented to make all groups of flashes fire the same flash output and ensure the total flash output is up to standard exposure.

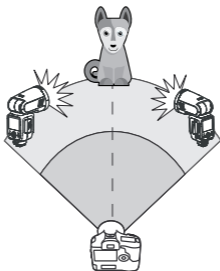

- ▲ 1. Press the depth-of-field preview button on the camera to fire a modeling flash(V100 C).
- 2. If the receiver unit's auto power off function is on, press the sender unit's test button to power it on. Please note that test firing is unavailable during the camera's regular metering time.
- 3. The effective time of receiver unit's auto power off is changeable between 30min or 90min in the menu settings.

M: Wireless Stroboscopic Flash Shooting with Manual Flash

Using wireless (multiple flash) shooting with manual flash, you can shoot with a different flash output setting for each receiver unit (flash group) while setting all parameters on the sender unit.

1. Click the "Sender" icon on the panel, then the V100 attached to the camera is set as the sender unit.

Click the "Sender" icon on the panel to enter sender mode. Press and hold the group box to switch to M manual flash power.

2. Set the flash output of each flash group

Click the – or + icon to adjust the flash output of each flash group.

3. Set the wireless channels and IDs of sender unit and receiver unit to the same.

For example, if the sender unit channel is set to 1, then the receiver unit channel needs to be 1 as well.

You can also use the wireless sync function to set the channels and ID to the same quickly.

4. Take Picture

Each receiver unit fires at the set flash ratio.

⚡ Wireless Stroboscopic Flash Shooting with Multi Flash

1. Set the Sender Unit to Wireless Multi Flash

Click the "Sender" icon onto the sender unit' LCD panel to enter sender settings. Slide the screen down to make the "Multi" icon appears and click to turn it on, then slide up to make the wireless multi flash parameters appear.

2. Set the Flash Output, Number of Flashes and Flash Frequency of the Wireless Multi Flash

Click the – or + icon can adjust the flash output, slide the number in front of "Times" can adjust the number of flashes, slide number in front of "Hz" can adjust the flash frequency.

3. Set the Receiver Unit

Click the "Receiver" icon onto the sender unit' LCD panel to enter receiver settings.

4. Set the Wireless Channels and IDs of Sender Unit and Receiver Unit to the Same

For example, if the sender unit channel is set to 1, then the receiver unit channel needs to be 1 as well.

5. Turn On/Off the Wireless Multi Flash of Receiver Unit Group

The wireless multi flash of receiver unit A/B/C/D/E can be turned on or off directly on the sender unit.

▲ The parameters of receiver unit can be directly set on the sender unit on the condition that channels and IDs of them are set to the same.

Other Applications

Sync Triggering

The sync cord jack is a $\Phi 2.5\text{mm}$ plug. Insert a trigger plug here and the flash will be fired synchronously with the camera shutter.

Modeling Flash(Only available in V100 C and V100 N)

If the camera has a depth-of-field preview button, pressing it will fire the flash continuously for 1 second. This is called modeling flash. It enables you to see the shadow effects on the subject and the lighting balance. You can fire the modeling flash during wireless or normal flash shooting.

- Note: 1. To avoid overheating and deteriorating the flash head, do not fire the modeling flash for more than 10 consecutive times. If you fire the modeling flash 10 consecutive times, allow at least 10 minutes' break for the camera flash.
2. The modeling flash cannot be fired with the Canon EOS 300 and Type-B cameras.
3. V100 S, V100 F and V100 O do not support modeling flash.

Bounce Flash

By pointing the flash head toward a wall or ceiling, the flash will bounce off the surface before illuminating the subject. This can soften shadows behind the subject for a more natural-looking shot. This is called bounce flash.

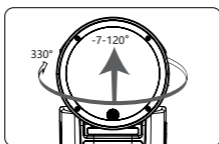

To set the bounce direction, hold the flash head and turn it to a satisfying angle.

- Note: 1. If the wall or ceiling is too far away, the bounced flash might be too weak and result in underexposure.
2. The wall or ceiling should be a plain, white color for high reflectance. If the bounce surface is not white, a color cast may appear in the picture.

Low Battery Warning

If the battery power is low, the $\langle \text{ } \rangle$ icon will turn red. Please replace or charge the battery immediately.

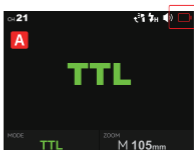

Control with the Camera's Menu(Only available in V100 C)

If the camera flash is attached to an EOS camera which has a camera control function, the flash can be controlled using the camera's menu screen.

The functions that can be set are as follows. The available settings vary depending on the flash mode, wireless flash function settings, and other conditions.

Function	
Flash Firing	On/Off
E-TTL Balance	Ambience priority/Standard/Flash priority
TTL Metering	Evaluative (Face priority) / Evaluative / Average
Continuous Flash Control	E-TTL shooting every time / E-TTL shooting for the first time
Flash synchronization speed in aperture-priority mode	
Flash Mode	TTL flash metering (auto flash) /manual flash/multi flash (stroboscopic)
Wireless Functions	Wireless flash: Off/Radio transmission
Zoom (Flash Coverage)	
Shutter Sync	First-curtain Sync/Second-curtain Sync /High-speed Sync
Flash Exposure Compensation	

Setting Camera Flash Functions

1. Select <Flash control> or <External Speedlite control>.

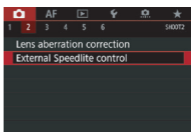

2. Select <Flash function settings> or <External func. setting >.

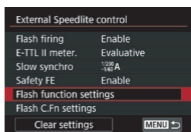

3. The setting screen and items displayed vary depending on the camera.

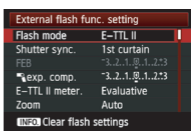

1. To clear all custom function settings, you can enter the [Clear settings] in step 2 and select [Clear all Speedlite C.Fn's] or [Clear ext. flash C.Fn set.].
2. If flash exposure compensation has already been set with the camera flash, flash exposure compensation cannot be set with the camera. To set it with the camera, the camera flash's flash exposure compensation must be set to zero.
3. If any flash custom functions and flash settings other than flash exposure compensation have been set by both the camera and the flash, the latest settings will take effect.

Global Shutter Sync Shooting(Only available in V100 S)

By using a combination of V100 S and a camera equipped with global shutter image sensor, flash photography can be synchronized with the entire range of shutter speeds available on the camera, enabling more effective flash exposures than conventional high-speed sync photography (HSS).

1. When V100 S is used in TTL auto flash mode with a global shutter camera, the flash will be synchronized properly at both low and high shutter speeds. Compared to a non-global shutter camera, with a global shutter camera, the HSS flash time is shorter (about 2-5 milliseconds), the recycle time is faster, and the camera can take more shots.

2. When V100 S is used in M (manual) flash mode and you want to use single pulse flash (not HSS) in high-speed shutter (with a shutter speed faster than 1/600), you can adjust the camera's flash delay time to match the exposure time, so that you can shoot with a more appropriate amount of light. Compared to HSS mode, this mode has a better flash index with the same power.

Flash timing settings: Camera Menu →  (Exposure/Color) → [Flash] → [Flash Timing Setting] → [On] → Set the flash timing to the desired value.

ADJ flash timing settings menu:

On: Adjusts the flash timing manually(0 microseconds to 1000 microseconds).

Off: Does not adjust the flash timing(the flash will fire in single pulse flash when the shutter speed is 1/600).

How to Match the Flash and the Shutter

High-speed shutter single pulse flash requires very strict time alignment. As shown in the figure, the shutter needs to be turned on at the optimal light effect of the flash. Matching method is as follows:

Set the flash to M (manual) flash mode and enter the menu, turn on ADJ in the camera flash timing settings. Input ADJ parameter which is related to the camera and flash used. If you are using V100S with A9MIII, this parameter is about 160 microseconds when V100S is wireless off, and about 560 microseconds when V100S is wireless on (if you are using other global shutter cameras, you need to full-time match to determine the time). After setting the above parameters, adjust the camera shutter to 1/80000 and the flash power to 1/256 (The matching requirements are higher for faster shutter speed and lower power, if you adjust the right combination, other combinations are usually suitable. When set to a fast shutter speed and high power, since the flash timing is much longer than the shutter time, you can move the time back and select the peak of the flash.), you can fine-tune the ADJ parameters to the optimal exposure time in case the flash is out of sync, then you can test the shootings under other shutters.

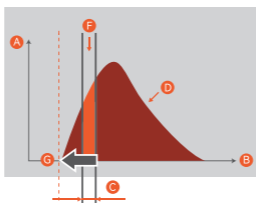

A: Amount of flash light

B: Time

C: Shutter speed

D: Amount of flash light in 1/256 power

F: Exposed amount of flash light

G: Flash starting timing

- ▲ 1. If you set the camera's shutter speed to faster than 1/10000 and take a picture, the brightness and color may vary.
- 2. For camera equipped with a global shutter image sensor, the HSS icon will not be displayed on the panel regardless of whether the high-speed sync setting is [ON] or [OFF].
- 3. When the flash is connected to the camera using a sync cord, the camera shoots with a traditional high-speed sync instead of using the global shutter sync, so the distance that the flash's light can reach is shortened.

Protection Function

Over-Temperature Protection

- To avoid overheating and deteriorating the flash head, do not fire more than 70 continuous flashes in fast succession at 1/1 full power. After 70 continuous flashes, allow a rest time of at least 10 minutes.
- If you fire more than 70 continuous flashes and then fire more flashes in short intervals, the inner over-temperature protection function may be activated and make the recycle time over 10 seconds. If this occurs, allow a rest time of about 10 minutes, and the flash unit will then return to normal.
- When the over-temperature protection is started, < > is shown on the LCD display.

Number of flashes that will activate over-temperature protection:

Number of Flash Flash Power	Focal Length	28mm	35mm	50mm	70mm	80mm	105mm
	1/1		70	75	80	90	100
1/2		106	114	120	134	150	150
1/4		215	231	240	273	300	300
1/8		300	300	300	300	300	300
1/16		1200	1200	1200	1200	1200	1200
1/32		3500	3500	3500	3500	3500	3500
1/64							
1/128							
1/256							

Number of flashes that will activate over-temperature protection in HSS mode:

Power Output Level	Number of Flashes
1/1	60
1/2 (+0.1~+0.9)	70
1/4(+0.1~+0.9)	100
1/8(+0.1~+0.9)	
1/16(+0.1~+0.9)	
1/32(+0.1~+0.9)	
1/64(+0.1~+0.9)	
1/128(+0.1~+0.9)	
1/256(+0.1~+0.9)	

Other Protections

The system provides real-time protection to secure the device and your safety. The following lists prompts for your reference:

Display	Meaning
Error1	A failure occurs on the recycling system so that the flash cannot fire. Please restart the flash unit. If the problem still exists, please send this product to a maintenance center.
Error3	The voltage on two outlets of the flash tube is too high. Please send this product to a maintenance center.
Error5	Abnormalities in the flash circuit. Please send this product to a maintenance center.
Error9	There are some errors occurred during the upgrading process. Please using the correct firmware upgrade method.

The Reason & Solution of Not Triggering in Godox 2.4G Wireless

1. Disturbed by the 2.4G signal in outer environment (e.g. wireless base station, 2.4G wifi router, Bluetooth, etc.)

→ To adjust the channel CH setting on the flash trigger (add 10+ channels) and use the channel which is not disturbed. Or turn off the other 2.4G equipment in working.

2. Please make sure that whether the flash has finished its recycle or caught up with the continuous shooting speed or not (the flash ready indicator is lightened) and the flash is not under the state of over-heat protection or other abnormal situations.

→ Please downgrade the flash power output. If the flash is in TTL mode, please try to change it to M mode (a pre-flash is needed in TTL mode).

3. Whether the distance between the flash trigger and the flash is too close or not (<0.5m).

→ Please turn on the "close distance wireless mode":

X1 Series: Press and hold the triggering button then turn on the device until the indicator blinks twice.

Xpro and X2T Series: Set the C.Fn-DIST to 0-30m.

X3 Series: Set the triggering distance to 0-30m.

4. Whether the flash trigger and the receiver end equipment are in the low battery states or not

→ Please replace the battery or charge it in time.

5. The flash trigger's firmware is an older version

→ Please upgrade the firmware of the flash trigger referring to the instruction manual for specific firmware upgrades.

6. The camera's firmware is an older version

→ Please upgrade the firmware of the camera referring to its instruction manual.

Technical Data

Model	V100 C	V100 S	V100 N
Global Shutter Sync	Unprovided	Provided	Unprovided
Radio Wireless Global Shutter Sync	Unprovided	Provided	Unprovided
Modeling Flash	Provided	Unprovided	Provided
Flash Coverage	Auto zoom (flash coverage is set automatically to match the lens focal length and image size)		
	Manual zoom(28-105mm)		

Model	V100 O	V100 F
Global Shutter Sync	Unprovided	Unprovided
Radio Wireless Global Shutter Sync	Unprovided	Unprovided
Modeling Flash	Unprovided	Unprovided
Flash Coverage	Auto zoom (flash coverage is set automatically to match the lens focal length and image size)	
	Manual zoom (28-105mm or 14-52mm)	Manual zoom (28-105mm or 18-69mm)





Model	V100 C/V100 S/V100 N/V100 O/V100 F
Power (1/1 output)	100Ws
Flash Head Angle	Swinging/tilting flash head (bounce flash): 0 to 330° horizontally and -7° to 120° vertically
Flash Duration	1/300s - 1/20000s
Exposure Control	
Exposure Control System	TTL auto flash and manual flash
Flash Exposure Compensation (FEC)	3 steps with 1/3 increment each step
Sync Mode	High-speed sync (up to 1/8000 seconds or 1/80000 seconds with Sony cameras equipped with global shutter), first-curtain sync, and second-curtain sync
Multi Flash	Provided (up to 100 times, 100Hz)
Wireless Flash (Radio 2.4G Transmission)	
Wireless Function	Sender, Receiver
Sender Groups	A, B, C, D, E(V100 C) M, A, B, C, D(V100 S/V100 N/V100 O/V100 F)
Controllable Receiver Groups	A, B, C, D, E
Transmission Range (approx.)	100m
Channels	32: 01~32
ID	OFF/01~99
Auto Focus Assist Beam(Unavailable in V100 O)	
Effective Range (approx.)	Center: 0.6~10m / 2.0~32.8 feet Periphery: 0.6~5m/2.0~16.4 feet
LED Modeling Lamp	
Power	2W
Color Temperature	3300K±200K
Power Supply	
Built-in Lithium Battery	7.2V/2980mAh
Recycle Time	Approx. 1.7 seconds. LED indicator will light up when the flash is ready.
Full Power Flashes	Approx. 400
Power Saving	Provide standby and auto off functions
Sync Triggering Mode	Hot shoe, 2.5mm sync cord
Dimension	
W x H x D	2.81*2.99*8.11"
Net Weight Without Battery	≈ 496g
Net Weight With Battery	≈ 616g

Specifications and data may subject to changes without notice.

Troubleshooting

If there is a problem, refer to this troubleshooting guide.

The camera flash does not fire.

- The camera flash is not attached securely to the camera.
→ Attach the camera's mounting foot securely to the camera.
- The electrical contacts of the camera flash and camera are dirty.
→ Clean the contacts.
- <  > or <  > is not displayed in the view finder of camera. < > or < > is not displayed in the view finder of camera.
→ Wait until the flash is fully recycled and the flash ready indicator lights up.
→ If the flash ready indicator lights up, but <  > or <  > is not displayed in the view finder, check whether this flash unit is securely attached to the camera hot shoe.
→ If the flash ready indicator does not light up after a long wait, check whether the battery power is enough. If the battery power is low, <  > will appear red on the LCD panel. Please replace or charge the battery immediately.

The power turns off by itself.

- Setting as wi-off/sender mode when the standby function is on, the flash will enter sleep mode automatically after 90 seconds of idle use.
→ Press the camera shutter halfway or press any button will wake up the flash unit.
- Setting as wi-off/sender mode when the standby function is off while the auto off function is on, the flash will automatically shut down after 60 minutes (or 30 minutes, 90 minutes) of idle use.
→ Restart the flash unit.
- Setting as receiver mode when the auto off function is on, the flash will automatically shut down after 60 minutes (or 30 minutes, 90 minutes) of idle use.
→ Restart the flash unit.

Auto zoom does not work.

- The camera flash is not attached securely to the camera.
→ Attach the camera flash's mounting foot to the camera.

The flash exposure is underexposed or overexposed.

- You used high-speed sync.
→ With high-speed sync, the effective flash range will be shorter. Make sure the subject is within the effective flash range displayed.
- You used manual flash mode.
→ Set the flash mode to TTL or modify the flash output.

Photos have dark corners or only parts of the target subject are illuminated.

- The focal length of lens exceeds the flash coverage.
→ Check the flash coverage you set. This flash unit has the flash coverage between 28 and 105mm, which fits medium-format cameras.

Firmware Upgrade

- This product supports firmware upgrade through the USB-C port, please use USB-C cable (sold separately).
- As the firmware upgrade needs the support of Godox G3 V1.1 software, please download and install the "Godox G3 V1.1 firmware upgrade software" before upgrading. Then, choose the related firmware file.
- Please refer to the latest electronic version of the instruction manual.
- The download website of firmware upgrade is:
<https://www.godox.com/firmware-flash/>

Compatible Camera Models

V100 C unit can be used on the following Canon EOS series camera models:

80D, 90D, 7D, 6D, 70D, 750D, 760D, 5DMarkIV, EOS 1DX, 6DMarkII, 77D, 800D, 5DMarkIII, 5DMarkII, 60D, 7D Mark II, 600D, 50D, 30D, 40D, 500D, M5, M3, M50, R, RP, M6II, R5, 1500D, 3000D, R7, R6II, R50, R8, R5C, R10, R100, R5II, R3, 200DII

V100 S unit can be used on the following Sony series camera models:

a77II, a99, a77, DSC-RX10, a6000, a7R, a6400, a7RII, a7RIII, a7M3, a9, a7RIV, a7R5, a7MIV, ZV-E10, a58, ILCE6000L, a7R3, a350, a9III

V100 N can be used on the following Nikon series camera models:

D800, D750, D700, D610, D500, D200, D300S, D5, D4, D810, D780, D5300, D5200, D5100, D5000, D3300, D3100, D60, Z6, Z7II, Z8, ZFC

V100 O unit can be used on the following camera models:

Olympus:E-M1, PEN-F, E-M10II, E-PL8, E-P5, E-M10III

Panasonic:GH4, LX100, DMC-GF1, DMC-G85, DMC-GX85, DMC-LX100, DMC-FZ2500GK, S1

V100 F unit can be used on the following Fujifilm series camera models:

Fujifilm cameras are divided into three kinds according to their different controlling ways to camera flash:

A: X-Pro2, X-T20, X-T2, X-T1, GFX50s, GFX50R, X-T30, X-T4, X-T3, X-S20, X-T5, X-H2, X-T50

B: X-Pro1, X-T10, X-E1, X-A3

C: X100F, X100T

Compatible camera models & functions support:

Camera	Camera Flash						
	TTL Flash			M Flash			HSS
	Front	Rear	HSS	Front	Rear	HSS	
A	√	√	√	√	√	√	√
B	√	√	--	√	--	--	√
C	√	√	√	√	√	√	√

Camera	2.4G Wireless Control						
	TTL Flash			M Flash			HSS
	Front	Rear	HSS	Front	Rear	HSS	
A	√	√	√	√	√	√	√
B	√	√	--	√	√	--	√
C	√	--	--	√	--	--	√

Camera	AF-assist Beam
A	√
B	--
C	--

- i** 1. X100T does not have second curtain sync (REAR), high-speed shooting and AF-assist beam functions.
 2. X-Pro1 and X-T10 does not have high-speed shooting and AF-assist beam functions. The front curtain sync (FRONT) and second curtain sync (REAR) are unadjustable in M manual flash mode.

- ▲** 1. This table only lists the tested camera models, not all cameras. For the compatibility of other camera models, a self-test is recommended.
 2. Rights to modify this table are retained.

IC Warning

Le présent appareil est conforme aux CNR d'Industrie Canada applicables aux appareils radio exempts de licence. L'exploitation est autorisée aux deux conditions suivantes:

- (1) l'appareil ne doit pas produire de brouillage, et
- (2) l'utilisateur de l'appareil doit accepter tout brouillage radioélectrique subi, même si le brouillage est susceptible d'en compromettre le fonctionnement

Tout changement ou modification non expressément approuvé par la partie responsable de la réglementation de l'OCDE peut faire perdre à l'utilisateur le droit d'utiliser l'appareil.

Remarque: cet appareil a été testé pour répondre aux limites des appareils numériques de classe B conformément à la partie 15 des règles de la Federal Communications Commission des États - Unis. Ces limites sont conçues pour fournir une protection raisonnable contre les interférences nuisibles dans les installations résidentielles. L'appareil génère de l'énergie RF utilisée et rayonne, ce qui peut causer des interférences nocives pour les communications radio s'il n'est pas installé et utilisé conformément aux instructions. Cependant, aucun

Garantie contre les interférences dans une installation spécifique. Si l'appareil cause des interférences nuisibles à la réception de la radio ou de la télévision, qui peuvent être déterminées en éteignant et en allumant l'appareil, l'utilisateur est encouragé à tenter de corriger les interférences par une ou plusieurs des mesures suivantes:

- redirection ou repositionnement de l'antenne de réception.
- augmenter l'espacement entre l'appareil et le récepteur.
- Connecter l'appareil à une prise sur un circuit différent de celui auquel le récepteur est connecté.
- consultez votre revendeur ou un technicien radio / tv expérimenté pour obtenir de l'aide.

Avertissement RF pour les appareils portables:

L'appareil a été évalué pour répondre aux exigences générales d'exposition aux radiofréquences. Équipement Peut être utilisé sans restriction dans des conditions d'exposition portables.

Warning

Operating frequency: 2412.99MHz – 2464.49MHz
Maximum EIRP Power:5.0dBm

Declaration of Conformity

GODOX Photo Equipment Co.,Ltd. hereby declares that this equipment are in compliance with the essential requirements and other relevant provisions of Directive 2014/53/EU. In accordance with Article 10(2) and Article 10(10), this product is allowed to be used in all EU member states.For more information of DoC, Please click this web link:

<https://www.godox.com/eu-declaration-of-conformity/>

The device complies with RF specifications when the device used at 0mm from your body.

FCC Statement

This device complies with part 15 of the FCC Rules. Operation is subject to the following two conditions: (1) This device may not cause harmful interference, and (2) this device must accept any interference received, including interference that may cause undesired operation.

Any Changes or modifications not expressly approved by the party responsible for compliance could void the user's authority to operate the equipment.

Note: This equipment has been tested and found to comply with the limits for a Class B digital device, pursuant to part 15 of the FCC Rules. These limits are designed to provide reasonable protection against harmful interference in a residential installation. This equipment generates uses and can radiate radio frequency energy and, if not installed and used in accordance with the instructions, may cause harmful interference to radio communications. However, there is no guarantee that interference will not occur in a particular

installation. If this equipment does cause harmful interference to radio or television reception, which can be determined by turning the equipment off and on, the user is encouraged to try to correct the interference by one or more of the following measures:

- Reorient or relocate the receiving antenna.
- Increase the separation between the equipment and receiver.
- Connect the equipment into an outlet on a circuit different from that to which the receiver is connected.
- Consult the dealer or an experienced radio/TV technician for help.

The device has been evaluated to meet general RF exposure requirement. The device can be used in portable exposure condition without restriction.

产品保修

尊敬的用户，本保修卡是申请保修服务的重要凭证，请您配合销售商填写并妥善保管，谢谢！

产品信息	型号	产品条码
用户信息	姓名	联系电话
	通信地址	
销售商信息	名称	
备注	联系电话	
	通信地址	
	销售日期	

注：此表应由销售商盖章确认。

适用产品

本文件适用于相关《产品保修资讯》（见后面说明）所列产品，其他非属此范围的产品或部件（如促销品、赠品及其他出厂后附加的部件等）不在此保修承诺内。

保修期

产品及部件的相应保修期按相关的产品保修信息执行。保修期自产品首次购买日起算，购买日以购买产品时保修卡登记日期为准。

如何获得保修服务

您可直接与产品销售商或授权服务机构联系，也可拨打神牛产品售后服务电话，与我们联系，由我们的服务人员为您安排服务。申请保修时，您应提供有效的保修卡作为保修凭证，方可获得保修。如您不能提供有效的保修卡，则在我们确认产品或部件属于保修范围的情况下，也可以为您提供保修，但这不作为我们的义务。

不适用保修的情况

如产品存在下列情况，本文件项下的保证和服务将不适用：①产品或部件超过相应保修期；②错误或不当使用、维护或保管导致的故障或损坏，如：不当搬运；非按产品合理预期用途使用；不当插拔外接设备；跌落或外力挤压；接触或暴露于不适当温度、溶剂、酸碱、水浸或潮湿环境；③由非神牛授权机构或人员安装、修理、更改、添加或拆卸造成的故障或损坏；④产品或部件原有识别信息被修改变更或删除；⑤无有效保修卡；⑥使用非合法授权、非标准或非公开发行的软件造成的故障或损坏；⑦因不可抗力或意外事件造成的故障或损坏；⑧其他非因产品本身质量问题导致的故障或损坏。遇上述情况，您应向相关责任方寻求解决，神牛对此不承担任何责任。因非在保修期或保修范围内的部件、附件或软件导致产品不能正常使用的，不是保修范围内的故障。产品使用过程中正常的脱色、磨损和消耗，不是保修范围内的故障。

产品保修

产品的保修期和服务类型按以下《产品保修信息》执行：

产品类别	选件名称	保修期(月)	保修服务类型
部件	主机	12	客户送修
	电池	3	客户送修
	充电器等带电性能的部件。	12	客户送修
其他	如闪光管、造型灯泡、外壳、保护罩、锁紧装置、包装等。	无	无保修

神牛产品售后服务电话：0755-29609320-8062

Warranty

Dear customers, as this warranty card is an important certificate to apply for our maintenance service, please fill in the following form in coordination with the seller and safe-keep it. Thank you!

Product Information	Model Name	Product Code Number Contact Number
Customer Information	Address	
	Name	
Seller Information	Contact Number	
	Address	
	Date of Sale	
Note		

Note: This form shall be sealed by the seller.

Applicable Products

The document applies to the products listed on the Product Maintenance Information (see below for further information). Other products or accessories (e.g. promotional items, giveaways and additional accessories attached, etc.) are not included in this warranty scope.

Warranty Period

The warranty period of products and accessories is implemented according to the relevant Product Maintenance Information. The warranty period is calculated from the day (purchase date) when the product is bought for the first time, and the purchase date is considered as the date registered on the warranty card when buying the product.

How to Get the Maintenance Service

If maintenance service is needed, you can directly contact the product distributor or authorized service institutions. You can also contact the Godox after-sale service call and we will offer you service. When applying for maintenance service, you should provide valid warranty card. If you cannot provide valid warranty card, we may offer you maintenance service once confirmed that the product or accessory is involved in the maintenance scope, but that shall not be considered as our obligation.

Inapplicable Cases

The guarantee and service offered by this document are not applicable in the following cases: ① The product or accessory has expired its warranty period; ② Breakage or damage caused by inappropriate usage, maintenance or preservation, such as improper packing, improper usage, improper plugging in/out external equipment, falling off or squeezing by external force, contacting or exposing to the improper temperature, solvent, acid, base, flooding and damp environments, etc; ③ Breakage or damage caused by non-authorized institution or staff in the process of installation, maintenance, alternation, addition and detachment; ④ The original identifying information of product or accessory is modified, alternated, or removed; ⑤ No valid warranty card; ⑥ Breakage or damage caused by using illegally authorized, nonstandard or non-public released software; ⑦ Breakage or damage caused by force majeure or accident; ⑧ Breakage or damage that could not be attributed to the product itself. Once met these situations above, you should seek solutions from the related responsible parties and Godox assumes no responsibility. The damage caused by parts, accessories and software that beyond the warranty period or scope is not included in our maintenance scope. The normal discoloration, abrasion and consumption are not the breakage within the maintenance scope.

Maintenance and Service Support Information

The warranty period and service types of products are implemented according to the following Product Maintenance Information:

Product Type	Name	Maintenance Period(month)	Warranty Service Type
Parts	Circuit board	12	Customer sends the product to designated site
	Battery	3	Customer sends the product to designated site
	Electrical parts e.g.battery charger, etc.	12	Customer sends the product to designated site
Other Items	Flash tube, modeling lamp, lamp body, lamp cover, locking device, package, etc.	No	Without warranty

Godox After-sale Service Call +86-755-29609320(8062)



Wechat
Official Account
神牛微信公众号

深圳市神牛摄影器材有限公司

地址：深圳市宝安区福海街道塘尾社区耀川工业园厂房 2 栋
电话：0755-29609320 (8062) 传真：0755-25723423 邮箱：godox@godox.com

GODOX Photo Equipment Co., Ltd.

Add.: Building 2, Yaochuan Industrial Zone, Tangwei Community, Fuhai Street, Bao'an District, Shenzhen 518103, China Tel: +86-755-29609320(8062)
Fax: +86-755-25723423 E-mail: godox@godox.com

www.godox.com

Made in China | 705-V100C0-12

